



**DP5000-Series
Telephone User Guide**

Important! *Toshiba Business Communications Division sells its products through Authorised Dealers. Our Dealers are certified in Sales and Technical Training for Toshiba products, and focus on providing the best possible customer experience. Dealer services include: network assessments, product recommendations, installations, and ongoing technical and sales support. Before making any changes or updates to their Toshiba Telecom product (hardware or software), Toshiba advises Businesses to contact their System's installing Dealer or an Authorised Toshiba Dealer in their area.*

To locate a Toshiba Telecom dealer, visit: www.telecoms.toshiba.co.uk

Publication Information

Toshiba Information Systems (UK) Ltd., Business Communications Division, reserves the right, without prior notice, to revise this information publication for any reason, including, but not limited to, utilization of new advances in the state of technical arts or to simply change the design of this document.

Further, Toshiba Information Systems (UK) Ltd., Business Communications Division, also reserves the right, without prior notice, to make such changes in equipment design or components as engineering or manufacturing methods may warrant.

DP5000-UG-VA

Version A, January 2008

© Copyright 2008 Toshiba Information Systems (UK) Ltd. Business Communications Division

All rights reserved. No part of this manual, covered by the copyrights hereon, may be reproduced in any form or by any means-graphic, electronic, or mechanical, including recording, taping, photocopying, or information retrieval systems-without express written permission of the publisher of this material.

Strata and Stratagy are registered trademarks of the Toshiba Corporation in Japan and other countries.

Trademarks, registered trademarks, and service marks are the property of their respective owners.

CAUTION! Do not use cleansers that contain benzene, paint thinner, alcohol or other solvents on the telephone's rubber feet. The color of the rubber may transfer to the desk or mounting surface.

WEEE COMPLIANCE STATEMENT

Business products that can be clearly distinguished from consumer products.

Following information is only for EU-member states:

The use of the symbol indicates that this product may not be treated as household waste. By ensuring this product is disposed of correctly, you will help prevent potential negative consequences for the environment and human health, which could otherwise be caused by inappropriate waste handling of this product. For more detailed information about the take-back and recycling of this product, please contact your supplier where you purchased the product.



ROHS COMPLIANCE STATEMENT

LICENSE AGREEMENT

Toshiba Information Systems (UK) Limited acting through its Business Communications Division ("TIU") - License Agreement. IMPORTANT: This License Agreement ("Agreement") is a legal agreement between the customer ("You") and TIU in respect of any switches, processors or other telecommunication products made available by TIU from time to time each of which is a "Product" for the purposes of this Agreement. Carefully read this Agreement. Use of any software or any related information (collectively, "Software") installed on or shipped with a Product or otherwise made available to you by TIU in whatever form or media, will constitute your acceptance of the terms of this Agreement, unless separate terms are provided by the Software supplier. If you do not agree to the terms of this Agreement, do not install, copy or use the Software and promptly return it to the location from which you obtained it in accordance with applicable return policies provided with the Software. Except as otherwise authorized in writing by TIU, the Software is licensed for distribution only to end-users pursuant to this Agreement.

1. License Grant. The Software is not sold; it is licensed upon payment of applicable charges. TIU hereby grants You a personal, non-transferable and non-exclusive right to use the copy of the Software provided under this Agreement. You agree You will not copy the Software except as necessary to use it on one Product at a time at one location. Any such copy shall in all respects be subject to the terms and conditions of this Agreement and shall be deemed to form part of the Software. Modifying, translating, renting, leasing, selling, charging, copying, distributing, transferring, assigning sub-licensing or otherwise dealing with or encumbering all or part of the Software, or any rights granted hereunder; using the Software on behalf of any other persons or making the Software available to any other persons; and/or removing or altering any proprietary notices, labels or marks from the Software are all strictly prohibited. You agree that violation of these prohibitions will cause irreparable harm to TIU and provide grounds for TIU to seek injunctive relief, without notice, against You or any other person in possession of the Software. You shall notify TIU immediately if You become aware of any unauthorized possession or use of the whole or any part of the Software by other persons. You and any other person whose possession of the Software violates this Agreement shall promptly surrender possession of the Software and Password to TIU, upon demand. Furthermore, you hereby agree not to create derivative works based on the Software.

2. Reservation of Rights. All rights not expressly granted by TIU to You under this Agreement are expressly reserved to TIU and/or its suppliers, and You acknowledge and agree that You are granted no right or benefit under or pursuant to this Agreement unless expressly stated.

3. Intellectual Property. You acknowledge that all rights of whatever nature in and to the Software are owned by and belong to TIU and/or its suppliers and that You will not acquire any rights to the Software, except the license expressly set forth above. The Software is protected under national patent, copyright, trade secret, and/or other proprietary laws, as well as international treaties. Any transfer, use, or copying of the software in violation of the Agreement constitutes infringement of copyright and/or other rights.

4. No Reverse Engineering. You agree that you will not attempt, and if you employ employees or engage contractors, you will use your best efforts to prevent your employees and contractors from attempting to reverse compile, reverse engineer, modify, adapt, translate or disassemble the Software in whole or in part (except and only to the extent that such activity is expressly permitted by applicable law).

5. Termination. Any failure to comply with the terms and conditions contained in this License or termination of TIU's arrangements with its suppliers will result in the automatic termination of this License without notice from TIU and the reversion of the rights granted hereunder back to TIU..

6. Limited Warranty. TIU warrants that any media on which the Software is furnished is free from defects in material and workmanship under normal use for a period of ninety (90) days from the date of delivery to You. Subject to the foregoing the Software is provided "as is" without warranty of any kind. Further to the maximum extent permitted by applicable law, TIU and its suppliers disclaim and hereby exclude all conditions, warranties and other terms with regard to the Software, including, but not limited to, any conditions, warranties and other terms of non-infringement of third party rights, year 2000 compliance, merchantability, satisfactory quality, and fitness for a particular purpose, relating to the ownership of the Software or as to price in every case whether express or implied by statute, common law, custom, collaterally or otherwise. The entire risk as to the quality and performance of the Software is with You. Neither TIU nor its suppliers, represent or warrant that the functions contained in the Software will meet your requirement or that the operation of the software will be uninterrupted or error-free. You accept that the Software was not designed and produced to your individual requirements and that You were responsible for its selection.

7. Limitation Of Liability. TIU's entire liability and your sole and exclusive remedy under this Agreement shall be at TIU's option replacement of the media containing the Software or refund of the price paid. To the maximum extent permitted by applicable law, in no event shall TIU or its suppliers be liable to You for damages for loss of profits or revenues or any consequential, special, incidental or indirect loss or damages (including claims for personal injury, business interruption, loss of business information/data) or any other pecuniary loss of any kind howsoever arising (whether in breach of contract, negligence or other tort, or otherwise) out of the use or inability to use the Software, even if TIU or its supplier has been advised of the possibility of such damages. In no event shall TIU or its suppliers be liable for any claim by a third party. TIU shall, however, accept liability for death or personal injury caused by its own negligence and as otherwise required by applicable law.

8. Governing Law and Jurisdiction. This Agreement shall be governed and construed in accordance with the laws of England. The Parties irrevocably submit to the exclusive jurisdiction of the English Courts in respect of any matter, claim or dispute arising under, out of, from or in connection with this Agreement.

9. Export Laws. This Agreement relates to Products, Software and/or technical data that may be controlled under the United States Export Administration Regulations and may be subject to the approval of the United States Department of Commerce prior to export. Any export, directly or indirectly, in contravention of the United States Export Administration Regulations, or any other applicable law, regulation or order, is prohibited.

10. United States Government Restricted Rights. The Software is provided with Restricted Rights. Use, duplication, or disclosure by the United States Government, its agencies and/or instrumentalities is subject to restrictions as set forth in subparagraph (c)(1)(ii) of The Rights in Technical Data and Computer Software Clause at DFARS 252.227-7013 (October 1988) or subparagraphs (c)(1) and (2) of the Commercial Computer Software - Restricted Rights at 48 CFR 52.227-19, as applicable.

11. Severability. If any provision of this Agreement shall be held to be invalid, illegal or unenforceable, the validity, legality and enforceability of the remaining provisions hereof shall not in any way be affected or impaired

12. No Waiver. No waiver of any breach of any provision of this Agreement shall constitute a waiver of any prior, concurrent or subsequent breach of the same or any other provisions hereof, and no waiver shall be effective unless made in writing and signed by an authorized representative of the waiving party.

13. Entire Agreement. In entering into this Agreement, You acknowledge and agree that You have not relied on any representation unless expressly included in this Agreement. You acknowledge that you have read this license agreement and that You understand its provisions. You agree to be bound by its terms and conditions. You further agree that this Agreement contains the complete and exclusive agreement between You and TIU and supersedes: (i) any proposal or prior agreement, oral or written, or any other communication relating to the subject matter of this license agreement; and (ii) any term or condition implied by trade custom or course of dealing and any purported contrary or inconsistent provision is hereby excluded. Nothing in this clause shall limit liability for fraudulent misrepresentation.

14. Third Party Rights. No provision of this Agreement shall be enforceable by any third party under the Contracts (Rights of Third Parties) Act 1999 or otherwise.

Toshiba Information Systems (UK) Limited.
Business Communications Division
Toshiba Court
Weybridge Business Park
Addlestone Road
Weybridge
Surrey
KT15 2UL

WARRANTIES FOR NON-TOSHIBA BRANDED THIRD PARTY PRODUCTS

A valuable element of Toshiba's product strategy is to offer our customers a complete product portfolio. To provide this value to our customers at the most optimal prices, we offer both Toshiba-branded and third-party manufactured products that support our Toshiba Strata CIX product portfolio. Similar to other resellers of software, hardware and peripherals, these third-party manufactured products carry warranties independent of our Toshiba limited warranty provided with our Toshiba-branded products. Customers should note that third-party manufacturer warranties vary from product to product and are covered by the warranties provided through the original manufacturer and passed on intact to the purchaser by Toshiba. Customers should consult their product documentation for third-party warranty information specific to third-party products. More information may also be available in some cases from the manufacturer's public website.

While Toshiba offers a wide selection of software, hardware and peripheral products, we do not specifically test or guarantee that the third-party products we offer work under every configuration with any or all of the various models of the Toshiba Strata CIX. Toshiba does not endorse, warrant nor assume any liability in connection with such third party products or services. If you have questions about compatibility, we recommend and encourage you to contact the third-party software, hardware and peripheral product manufacturer directly.

This page is intentionally left blank.

Contents

Introduction

Organisation.....	vii
How to Use This Guide.....	viii
Conventions	viii
Related Documents/Media.....	x

Chapter 1 – The Grand Tour

DP5000-series Telephone Overview	5
Fixed Buttons.....	6
Programmable Feature Buttons	8
Key Strip.....	8
LCD.....	9
9-Line LCD Display	9
4-Line LCD Display	10
Soft Keys.....	10

Chapter 2 – The Basics

Customising Your Telephone	11
Volume Control	11
Volume Control for the Single Line Telephone	12
LCD Contrast.....	13
Brightness Control.....	13
Backlight On/Off	14
Keystrip Labels	15
Ring Tones	15

Contents

Chapter 3 – Feature Operations

Dial Pad and Button Beeps	16
Speakerphone/Microphone Sensitivity Adjustment	17
Telephone Terminology	18
Making a Call.....	19
Handset	19
Spkr Button.....	19
Hot Dialling	19
Dial Directory	20
Answering a Call.....	21
Handset	21
Speaker	21
Handsfree Answerback.....	21
On a Call	22
Switching Between Handset and Speakerphone.....	22
Microphone (Mic/Mute) Button	22
Hold	22
LED Indicator Details.....	24

Chapter 3 – Feature Operations

Account Code Calls	25
Verified/Non-Verified Account Codes.....	25
Forced Account Codes.....	26
Voluntary Account Codes (Verified/Non-Verified).....	27
Advisory Messages	28
Alarm Notification Button	29
Automatic Busy Redial	29
Automatic Callback	30
Background Music	31
Call Forward	32
System.....	32
Station	32
Station Call Forward Categories.....	33
Call Forward Settings	33
Station Call Forward Procedures	34
Call Forward Examples	35

Call Park Orbits.....	36
Call Pickup.....	37
Group Pickup.....	37
Ringing, Page or Held Call Pickup.....	37
Call Transfer.....	39
Call Waiting.....	40
Caller ID.....	41
Conference Calls.....	41
Adding Voice Mail to a Conference.....	42
Supervising a Tandem Call.....	43
Conference Add/Split/Join/Drop.....	43
Direct Inward System Access (DISA).....	45
Direct Station Selection Buttons (Hotline).....	45
Do Not Disturb.....	46
Setting DND for Another Extension.....	47
Door Lock(s).....	47
Door Phone(s).....	48
Emergency Call.....	49
Emergency Monitoring Station.....	49
Emergency Ringdown.....	50
Language Codes.....	50
Message Waiting.....	51
Turning On/Off MW LED on Another Extension.....	52
Microphone Cut-Off.....	53
Off-hook Call Announce.....	54
Override Calls.....	55
Busy Override.....	55
Do Not Disturb Override.....	55
Executive Override.....	56
Destination Restriction/Traveling Class Override.....	56
Class of Service Override.....	56
Privacy Override.....	57
Paging.....	57
Answering a Page.....	57
All Call Page.....	58

Contents

Chapter 4 – ADM/DSS Console

Emergency Page	58
Privacy	59
Redial	59
Speed Dial	60
Making a Call Using Speed Dial	60
Storing a System/Station Speed Dial Number	61
Advanced Speed Dial Operation	62
Storing Personal Speed Dial Names	63
Tone First / Voice First Signalling	65
Tone First Signalling	65
Voice First Signalling	65
Tone/Pulse Dialling	66
Uniform Call Distribution	67
Login/Logout	68

Chapter 4 – ADM/DSS Console

Add-on Modules	69
ADM	70
Buttons and LEDs	70
Adding an ADM	71
Brightness Control	71
Keystrip Labels	71
DSS Console	72
DSS Buttons	72
Calling a Station	72
Transferring to an Idle Station	73
Call Transfer with Camp-on	74
Call Answering (Outside Line)	74
Speed Dial	74
Paging	75
Call Forward Override (DSS Override)	75
Night Transfer Button	75

Chapter 5 – Headset and Handset Operation

Recommended Headsets77
 Headset and Handset Interactions77
 AUTO or CARBON Setting78
 Headset Transmit Level Adjustments80
 Handset Level Adjustments81

Chapter 6 – User Programming

Programming Feature Buttons84
 User Programming Mode84
 Programmable Feature Button Codes84
 Setting/Changing a Programmable Feature Button’s Function85
 One Touch Buttons86
 Changing a One Touch Button86
 To Use a One Touch Button87
 Setting/Changing a Personal Speed Dial Code.....87
 Feature Codes.....88

Chapter 7 – Administrator Programming

Functions93
 Administrator Mode.....94
 Phone Name.....94
 Door Name.....95
 System SD/Name.....95
 Phone Key Label and LM Key Label95
 Station SD/ Name96
 Exchange (CO) Line Name96
 DNIS Name96
 System Features97
 Direct Inward System Access (DISA) Security Code97
 Date and Time Setting99
 Telephone Programming Mode100
 Initialise Telephone Settings.....100
 Call Waiting and Camp-on Ring Tone Over Handset/Headset Option.....101

Contents

Appendix A – References

Initialise or Adjust LCD Contrast.....	101
DKT2000 Mode On/Off	102
Single Line Telephone	103
Buttons	103
Redial Button Activation / Deactivation.....	104
Msg / Feature Button Activation / Deactivation.....	104

Appendix A – References

Call Forward	105
Soft Keys.....	109
Button Labels	110

Appendix B – Hardware Connections

DP5000-Series Telephone Tilt Angles	115
Wiring	117

Appendix C – Centrex Application

Note The Centrex Application feature applies to US models only.

Flexible Directory Numbering	119
Centrex Feature Buttons	119
Ringing Repeat.....	120
Delayed Ringing	120

Index

Introduction

This user guide describes how to use the Toshiba DP5000-series telephones with the Strata CIX670, CIX200, CIX100, CIX100-S, and CIX40 telephone systems. These include:

- Strata DP5000-series digital telephones shown in [Table 1 on Page 2](#).
- Strata Digital Add-on Modules.
- Strata Direct Station Selection (DSS) console.

Note Telephones and ADM models that include “1” in the model number are models that support the backlight feature.

Organisation

- **Chapter 1 – The Grand Tour** provides an overview DP5000 digital telephones.
- **Chapter 2 – The Basics** covers the basic telephone functions.
- **Chapter 3 – Feature Operations** includes an explanation of Soft Key operations, an alphabetical feature list and LCD information.
- **Chapter 4 – ADM/DSS Console** explains features and functions of the Add-on modules.
- **Chapter 5 – Headset and Handset Operation** explains the interactions of these accessories with the DP5000-series telephones.
- **Chapter 6 – User Programming** explains how to program the Programmable Feature Buttons, such as setting One Touch buttons, changing Personal Speed Dial numbers, as well as other user programmable functions.
- **Chapter 7 – Administrator Programming** explains features and functions to be performed by an Administrator.

Introduction

How to Use This Guide

- **Appendix A – References** includes tables that support procedures in the Basic and Feature Operation chapters.
- **Appendix B – Hardware Connections** includes tilt angles and telephone wiring diagrams.
- **Appendix C – Centrex Application** describes the Centrex features which may be available with your Strata CIX system.

Important! Please Note the Centrex Application feature in Appendix C is available on US models only.

How to Use This Guide

This guide provides in-depth instructions for the DP5000-series telephones and their features. Most telephone users can use the “*Strata CIX DP5000-series Quick Reference Guide*” instead of this guide.

Conventions

Note Elaborates specific items or references other information. Within some tables, general notes apply to the entire table and numbered notes apply to specific items.

Important! *Calls attention to important instructions or information.*

CAUTION! **Advises you that hardware, software applications, or data could be damaged if the instructions are not followed closely.**

WARNING! Alerts you when the given task could cause personal injury or death.

Conventions	Description
[DN]	Represents any Directory Number button, also known as an extension or intercom number. Telephones can have multiple extensions. Incoming calls ring extensions bottom to top.
[PDN]	Represents any Primary Directory Number button (the extension number for the telephone).
[SDN]	Represents any Secondary appearance of a PDN. A PDN which appears on another telephone is considered an SDN.
[PhDN]	Represents any Phantom Directory Number button (an additional DN).
Arial Bold	Represent telephone buttons.
Courier	Shows a computer keyboard entry or screen display.
Arial	Represents LCD displays, tokens or custom IVR functions.
“Type”	Indicates entry of a string of text.
“Press”	Indicates entry of a single key. For example: Type prog then press Enter .
Plus (+)	Shows a multiple PC keyboard or phone button entry. Entries without spaces between them show a simultaneous entry. Example: Esc + Enter . Entries with spaces between them show a sequential entry. Example: #+5 .
Tilde (~)	Means “through.” Example: 350~640 Hz frequency range.
➤	Denotes the step in a one-step procedure.
➤	Denotes a procedure.
Start > Settings > Printers	Denotes a progression of buttons and/or menu options on the screen you should select.

Introduction

Related Documents/Media

Conventions	Description
See Figure 10	Grey words within the printed text denote cross-references. In the electronic version of this document (Library CD-ROM or Partner Portal download), cross-references appear in blue hypertext.

Related Documents/Media

Note Some documents listed here may appear in different versions on the electronically or in print. To find the most current version, check the version/date in the Publication Information on the back of the document's title page.

Refer to the following for more information:

- Strata CIX General Description
- Strata CIX DP5000-series Telephone Quick Reference Guide
- Strata CIX Installation and Maintenance Manual
- Strata CIX Programming Manual - Volume 1
- Strata CIX My Phone Manager User Guide

Important!

Business Communications Division use this opportunity to inform Customers/End-users that the new DP5000 terminals will only work with the Netserver 4.3.46F and above as it is not compatible with the older versions of Netservers

Also, TIU BCD hereby alerts reader's attention to the fact that even though some images might appear with different key labels, they imply the same terms. (For example: "flex means Redial" and in some cases word labels might be used to replace symbols like Speaker, Microphone or Conference/ Transfer).

The DP5000-series digital telephones connected to a Strata CIX telephone system include a wide selection of digital telephone models and matching digital add-on modules and a 60-button DSS Console. See [Table 1](#) for more details.

Through dynamic soft key assignments, the LCD telephones provide easy access to frequently-used features by prompting specific tasks, providing Outside Line Identification, User Name/Number, Call Duration, Date/Time of Day displays, and Name and number displays of incoming callers.



The speakerphone on these telephones enables you to place and receive calls without lifting the handset.

The LCD telephones with 10 and 20 buttons are available with LCD backlight. To change the backlight settings, refer to [Chapter 3 – Feature Operations](#).

Table 1 DP5000 Series Digital Telephones



Description	Image
<p>Digital Single Line Telephone:</p> <ul style="list-style-type: none"> • On hook dialling • Headset I/F • Ringing LED • Non-display 	
<p>10 Button Digital Telephone:</p> <ul style="list-style-type: none"> • Half duplex Speakerphone • Headset I/F • Ringing LED • Non-display 	
<p>10 Button Digital Telephone:</p> <ul style="list-style-type: none"> • 4 line LCD with back light option • Half duplex Speakerphone • Headset I/F • Ringing LED 	

Table 1 DP5000 Series Digital Telephones *(continued)*

Description	Image
<p>20 Button Digital Telephone:</p> <ul style="list-style-type: none"> • 4 line LCD with back light option • Half duplex Speakerphone • Headset I/F • Ringing LED 	
<p>10 Button with Electronic LCD Labels:</p> <ul style="list-style-type: none"> • 9 line LCD with back light • Half duplex Speakerphone • Headset I/F • Ringing LED 	

The DP5000-series telephone upgrade options include:

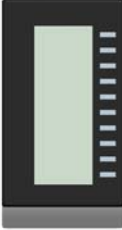
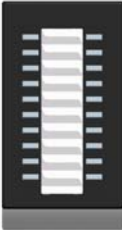
Table 2 DP5000 Series Add-on Modules

Description	Image
<p>10 Button ADM for DP5000-series</p> <ul style="list-style-type: none"> LCD programmable key strip with back light 	
<p>20 Button ADM for DP5000-series</p> <ul style="list-style-type: none"> Paper Key Strip 	
<p>60 Button DSS for DP5000-series</p> <ul style="list-style-type: none"> Paper Key Strip 	

DP5000-series Telephone Overview

The illustration of the DP5000-series telephone shown below gives a general idea of the basic attributes found on most of these telephones. The positioning of the buttons varies per telephone model.



20 Programmable Feature Buttons 4-Line LCD Telephone

Legend

- | | |
|-------------------------------------|-----------------------|
| A. Status LED (message and ringing) | G. Speaker LED Button |
| B. LCD Display | H. Volume |
| C. Softkeys | I. Hold Button |
| D. Programmable Feature Buttons | J. Microphone |
| E. Message Waiting LED Button | K. Tilt stand |
| F. Microphone LED Button | |

Fixed Buttons

The fixed buttons on the dial pad help perform standard functions quickly and easily.

Layouts

Fixed buttons are laid out differently on the DP5000-series telephones.



The Fixed buttons are described below.

Table 3 Fixed Button Definitions









Button	Definitions
	<p>Message (Msg): When Msg LED flashes, press Msg to call back the station or voice mail device that activated the LED. This is the telephone's [PDN] message waiting button.</p> <p>Important! <i>Red LED must be on in order for button to function.</i></p>
	<p>Microphone (Mic/Mute) button toggles between Mic and Mute. When Mic key is lit, handsfree communication is supported, when Mic is pressed again and light is off, Mute is enabled on the microphone in the telephone and the microphone in the handset.</p>
	<p>Speaker: Press to toggle the speaker ON/OFF. When red Speaker LED is lit handsfree communications is supported.</p> <p>To start a handsfree conversation; press the Speaker button, this turns the red Speaker LED on. To terminate this call press the Speaker button again (Speaker LED off).</p> <p>During a handset conversation, press the Speaker button to start hands-free communications (red Speaker LED on). Press the Speaker button again to transfer the conversation back to the handset (Speaker LED off).</p>
	<p>Press and release the volume control bar to adjust volume levels. See "Volume Control" on page 11.</p> <p>Important! <i>Continuously holding the volume button (up or down) does not change the volume. It is adjusted on a per press basis.</i></p>
	<p>Press Spdial and enter 3-digit Speed dial access code. Speed dial access codes must be setup before they can be accessed. See "Speed Dial" on page 60.</p>
	<p>Press Redial to dial the last telephone number called (internal or external).</p> <p>If you have Automatic Line Selection, lift the handset first.</p>

Table 3 Fixed Button Definitions *(continued)*

Button	Definitions
 (Conference/Transfer)	Press Cnf/Trn to add internal or external parties to a conference call (up to 8 parties). Press Cnf/Trn and enter a number to transfer a call to another party (on the CIX system).
	Press Hold to place an internal or external call on hold. Press Hold Hold to place an internal or external call on Exclusive hold. If your telephone is programmed for Automatic Hold, existing calls are automatically placed on hold when you answer a call or make another call.

Programmable Feature Buttons

Programmable Feature Buttons are programmed by the System Administrator and can be customised on a per user basis.

See [Table 17 on page 110](#) for a list of Programmable Feature Buttons.

Note Programmable Feature Buttons are numbered bottom to top, left to right (shown right).

Key Strip

The key strips on the DP5000-series telephones and add-on modules are either electronic (programmable) or paper (refer to [Table 1](#) and [Table 2](#)).

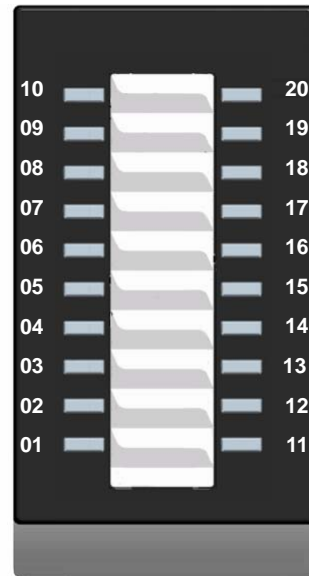

Programmable Feature Button Layout

LCD

If your telephone has an LCD, use this section to learn more about its functions.

9-Line LCD Display

The LCD on the 9-Line LCD telephone (shown below) in idle state shows:

Top to Bottom

Line 1 or the top line of the LCD will display your user name (if programmed) and your extension number.

Line 2 will show the Date and time.

Line 3 will show information related to your telephone set: VM New/Saved messages, Call Forward, or if a certain feature is enabled on your telephone set.

A plus sign + on the LCD indicates there is more data to display. Press SCRL to advance through the information.

Lines 4~8 will indicate Programmable Feature Button labels.

Line 9 will display the Soft Keys (See [“Soft Keys” on page 10](#)).

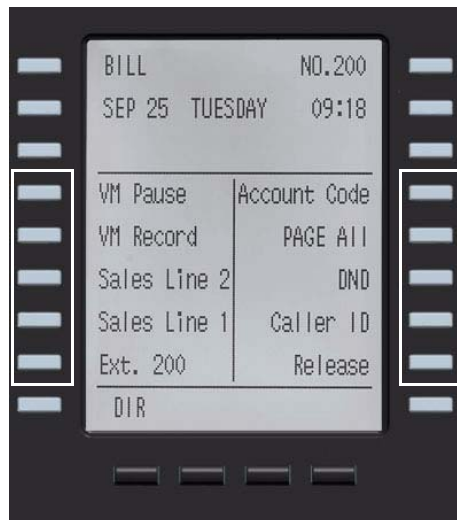

4-Line LCD Display

The LCD in it's idle state (shown right) displays:

Line 1 or the top line of the LCD will display your user name (if programmed) and your extension number.

Line 2 will show the Date and time.

Line 3 will show information related to your telephone set: VM New/Saved messages, Call Forward, or if a certain feature is enabled on your telephone set.

A plus sign + on the LCD indicates there is more data to display. Press NEXT to advance through the information.

Line 4 will display the soft keys available in idle state. Press DSPLY to switch from the Call Forward display to the User Name display.

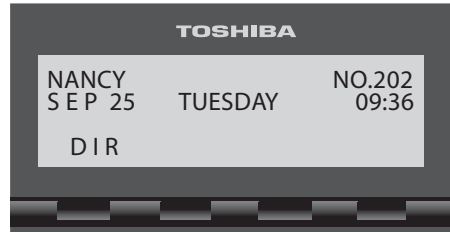

DP5000 4-line LCD display in Idle Mode

Soft Keys

Softkeys (SK1 - SK4) refer to the four buttons directly below the LCD screen (shown right). Soft Keys dynamically change their functions and label depending on the state of the telephone. The dynamic feature associated with the Soft Key is displayed on the bottom line of the LCD display directly above each Soft Key button.

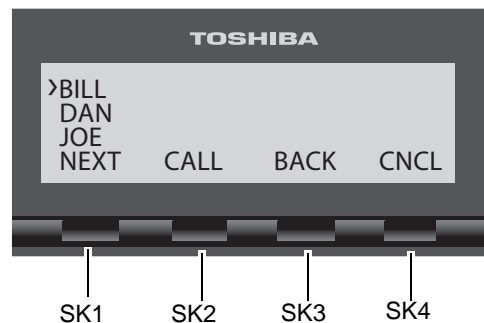

This chapter reviews the basic operations of the DP5000-series telephones. The instructions apply to all telephone models, except when noted otherwise.

Customising Your Telephone

Volume Control

Note The Volume Control instructions for the Single Line Telephone are on the next page.

➤ **To adjust the handset volume**

➤ Press the Vol ▲ to increase volume and Vol ▼ to decrease volume during the call. When you hang up, the volume returns to the default setting.

➤ **To adjust the speaker volume for internal/external calls and background music**

1. Press Spkr.
2. Press an extension button - you hear dial tone.
3. Press the Vol ▲ to increase volume and Vol ▼ to decrease volume. This volume setting applies to all calls until changed.

➤ **To adjust Ring Tone, Hands free Answerback and Speaker Off-hook Call Announce**

➤ Make sure the telephone is idle and the handset is on-hook. Press the Vol ▲ to increase volume and Vol ▼ to decrease volume. This adjusts volume for your telephone's ring tone, Hands free Answerback and Speaker Off-hook Call Announce simultaneously.

➤ To adjust handset Beep Tone

1. With the handset off-hook, dial the Beep Tone Adjustment Code #6101 (default code). You hear busy tone.
2. Press Vol ▲ or Vol ▼ to reach the desired level.

Volume Control for the Single Line Telephone

- Press the Vol ▲ to increase volume and Vol ▼ to decrease volume during it.

➤ To adjust the handset volume

- Press the Vol ▲ to increase volume and Vol ▼ to decrease volume during the call. When you hang up, the volume returns to the default setting.

➤ To adjust the speaker volume for internal/external calls and background music

1. Press 
2. Press an extension button - you hear dial tone.
3. Press the Vol ▲ to increase volume and Vol ▼ to decrease volume. This volume setting applies to all calls until changed.

➤ To adjust Ring Tone

- Make sure the telephone is idle and the handset is on-hook. Press the Vol s to increase volume and Vol t to decrease volume.

LCD Contrast

Available on backlit telephones and backlit add-on module.

► To adjust the LCD contrast on the backlit telephones

1. Press and hold down the  button.
2. Press and release Vol ▲ or Vol ▼ repeatedly.

Note Holding the Vol button does not continue to change the setting. The button must be pressed for each step of contrast change.

► To adjust the LCD contrast on the Add-on Module

1. Press  +3+6+9 (simultaneously).
2. Press Contrast + button to increase contrast.
3. Press Contrast - button to decrease contrast.
4. Lift the handset off-hook / on-hook to save settings.

Note Holding the softkey does not continue to change the setting. The softkey must be pressed for each step of contrast change

Brightness Control

Available on backlit telephones and backlit add-on module.

► To change the LCD back light brightness

1. Press  +3+6+9 (simultaneously).
2. Press Bright softkey to increase brightness.
3. Press Dim softkey to decrease brightness.
4. Lift the handset off-hook / on-hook to save the settings.

Note Use the Bright and Dim buttons in steps 2 and 3 on the 10 button LCD Add-on Module.

Backlight On/Off

Available on backlit telephones and backlit add-on module.

► To change Backlight Settings



1. Press  +3+6+9 (simultaneously).
2. Press the  button.
3. Use table below to choose preferred settings.
4. Press  to save settings

Table 4 Backlight Settings

FB4	FB3	FB2	FB1	Meaning	Delay (in Seconds)
On	On	On	On	Always On	None
On	On	On	Off	Synchronised	300
On	On	Off	On	Synchronised	240
On	On	Off	Off	Synchronised	180
On	Off	On	On	Synchronised	160
On	Off	On	Off	Synchronised	140
On	Off	Off	On	Synchronised	120
On	Off	Off	Off	Synchronised	100
Off	On	On	On	Synchronised	80
Off	On	On	Off	Synchronised	60
Off	On	Off	On	Synchronised	50
Off	On	Off	Off	Synchronised	40
Off	Off	On	On	Synchronised	30 (Default)
Off	Off	On	Off	Synchronised	20
Off	Off	Off	On	Synchronised	10
Off	Off	Off	Off	Always Off	None

Note FB1 is the lower left key, FB2 in the next up, FB3 is above FB2, and FB4 is above FB3.

Keystrip Labels

Available on 9 Line LCD telephone and 10 Button LCD Add-on Module

► To program LCD Keystrip Labels

1. Dial #9876 (or press the flexible Program button)
2. Press the  button.
3. Press the button you wish to label.
4. Use the dialpad to enter the label.
5. Press the button labeled in step 3 to save the setting.
6. To label another button, repeat steps 3-5.
7. To exit User Programming mode lift the handset off-hook / on-hook.

Ring Tones

► To set distinctive ringing



1. Press #9876 to enter User Programming Mode.
2. Press a Line or extension button. The LED is steady green.
3. You can press  to switch between internal and external pitch. (Internal = station calls within your system; external = outside line calls.)
4. Enter the two-digit pitch number (see [Table 5 on page 16](#)).
5. Press the same button that you pressed in Step 2 (Line or extension). Two beeps is a confirmation tone and “DATA PROGRAMMED” displays on your LCD.
6. Lift the handset off-hook/on-hook to save settings.

Table 5 Internal and External Call Ringing Tones



Tone No.	Frequency and Cadence
01	500 Hz 1 sec. On, 3 sec. Off, repeat
02	1300 Hz 1 sec. On, 1 sec. Off, repeat
11	500/640 Hz 1 sec. On, 3 sec. Off, repeat
12	500/640 Hz 1 sec. On, 1 sec. Off, repeat
13	860/1180 Hz 1 sec. On, 3 sec. Off, repeat
14	860/1180 Hz 1 sec. On, 1 sec. Off, repeat
15	1300/1780 Hz 1 sec. On, 3 sec. Off, repeat
16	1300/1780 Hz 1 sec. On, 1 sec. Off, repeat
17	860/1180 Hz 0.5 sec. On, 1300/1780 Hz 3 sec. Off, repeat
18	860/1180 Hz 0.5 sec. On, 1300/1780 Hz 1 sec. Off, repeat

Dial Pad and Button Beeps

Digital telephones can emit a “beep” whenever a dial pad or feature button is pressed. The “beeps” are On by default. Follow these steps to turn the “beeps” On or Off.



1. Press 3+6+9+  (simultaneously).
2. Press 0.
3. Press Programmable Feature Button 1 (FB1) to toggle On/Off.
 FB1, LED On: buttons beep.
 FB1, LED Off: buttons do not beep.
4. Press  to set the option.
5. You must also go off-hook, then on-hook to exit the program mode.

For Single Line Telephone

1. Press 3+6+9+  (simultaneously).
2. Press 0 1.
3. Press  to toggle On/Off.
 Msg LED On: buttons beep.
 Msg LED Off: buttons do not beep.
4. Press  to set the option.
5. You must also go off-hook, then on-hook to exit the program mode.





Speakerphone/Microphone Sensitivity Adjustment

When you are using the speakerphone, high ambient noise levels may cause the party you are talking with to be cut off frequently. If this happens, follow these steps to lower the sensitivity of the microphone on a DP5000-series telephone. The default is normal sensitivity.

1. Press 3+6+9+  (simultaneously).
2. Press 0.
3. Press Programmable Feature Button 3 (FB3) to toggle On/Off.
FB3, LED On: Lower sensitivity
FB3, LED Off: Normal sensitivity
4. Press  to set the option.
5. Go off-hook, then on-hook to exit the program mode.

Telephone Terminology

When making or receiving calls on your DP5000-series telephone you may experience one or more of the following call features depending on how your telephone is configured.

- **Line** – is synonymous with trunk which is the line that connects you to the PSTN (Public Switched Telephone Network). Line can be:
 - a button on your telephone set designated for outgoing calls
 - your DN button followed by dialling 9.
- **Automatic Line Selection (ALS)** – ALS is engaged on outgoing calls. Lift the handset or press  to hear dial tone, the steady green Line LED indicates ALS is enabled. The second line of the LCD will display the method of dialling available, followed by the digits dialled.
- **Ring Line Preference** – Answer any incoming call by lifting the handset or pressing . There is no need to press the ringing line button to answer the call when ringing line preference is enabled.
- **Tone First Signalling** – Internal incoming calls only: telephone rings in standard ring tone, lift handset or press  to answer call.
- **Voice First Signalling** – Internal incoming calls only: a long tone is heard, followed by the caller's voice, this will automatically engage the  to allow for hands free communications. Lift the handset if desired (for privacy). When Voice First Signalling is enabled the telephone does not ring on internal incoming calls.
- **Hot Dialling** – Dial a telephone number from the dialpad, the telephone automatically selects a line, shown with a green LED, and turns on the Spkr and Mic LED's. When Hot Dialling is not turned on the handset should be lifted or Spkr should be pressed in order to make a call.

Making a Call

There are three ways to originate a call from the telephone:

Handset

1. To make a call, lift the handset, then dial the number.

A line may be automatically selected or choose a line manually. Dial tone is heard through the handset. The Speaker and Microphone LEDs do *not* light.

Digits display as they are dialled. Call progress tones (Ringback Tone, Busy Tone, etc.) are heard through the handset.

2. When connected, continue using the handset or switch to speakerphone by holding down  and placing the handset in the cradle.

Spkr Button

1. To make a call, press .

A line may be selected automatically or choose a line manually. The extension or Line button lights (depending on system programming). Dial tone is heard through the speaker. The Speaker and Microphone LEDs light.

2. Dial the number.

Digits display as they are dialled. Call progress tones (Ringback Tone, Busy Tone, etc.) are heard through the speaker.

3. When connected, continue using the speakerphone or lift the handset to continue the conversation.

Hot Dialling

1. To make a call using Hot Dialling, start dialling the number.

The extension button, Spkr and Mic LEDs light. Digits display as they are dialled. Call progress tones (Ringback Tone, Busy Tone, etc.) are heard through the speaker.

2. When connected, continue using the speakerphone or lift the handset to continue the conversation.

Dial Directory

This feature is supported on DP5000-series telephones with an LCD display running on CIX R5.1 (or higher) software. Calls can be made by selecting a name from the alphabetical telephone directory.

► To access the Directory

1. Press DIR soft key (shown right).
Select Directory menu appears.

Note The soft keys on the Select Directory are:
My = Personal Speed Dial Names
EXTR = System Speed Dial Names
INTR = Directory Number Names
Dial = Cancel directory, get dial tone.

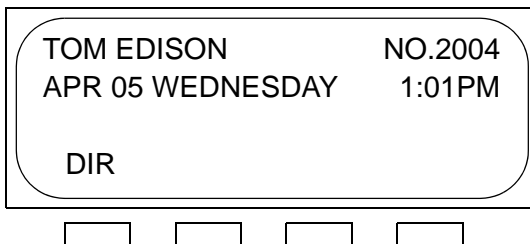

2. Choose the directory you wish to access and use the dial pad to enter the name.

Notes

- If a directory is not selected and a name is entered, all directories will be searched.
 - To enter names from the dial pad, press the dial pad button associated with the letter to be entered. Press the button once for the first letter, twice for the second letter, etc. Left and Right Soft Keys are available to move the cursor.
3. Press Find to start the directory search.
 4. Press Next to move forward through the directory.
 5. Press Back to move backwards through the directory.
 6. Press Call to connect to the directory entry selected.
 7. Press Cncl to quit the directory search.

Answering a Call

There are several ways to answer a call:

Handset

- When the telephone is programmed for Ringing Line Preference, pick up the handset and the telephone automatically answers the ringing line.
... or press the button associated with the ringing line (flashing green LED).

Speaker

- When the telephone is programmed for Ringing Line Preference, press  and the ringing line is answered.
... or press the button associated with the ringing line (flashing green LED). Once connected, continue using the speakerphone or lift the handset.

Handsfree Answerback

With speakerphone enabled, the telephone may be programmed for Handsfree Answerback. The called party hears a single long tone, followed by the caller's voice. Begin hands free conversation. If Handsfree Answerback were not programmed, the called party could hear the calling party speak but would not be able to answer them without answering the call manually.

Notes

- The extension LED flashes green, the Microphone LED lights steady red and the Speaker LED flashes Red.
- In order to perform any additional functions with this call (like a transfer or hold) the call must be properly answered to gain full call control. Perform the same steps you normally would to answer a call: press the Spkr button, the flashing DN button or lift the handset.
- Handsfree MIC setting needs to be enabled by your System Administrator.

On a Call

While on a call you can perform the following:

Switching Between Handset and Speakerphone

- Press  and place the handset on-hook to switch from handset to speakerphone mode.
- Take the handset off-hook to switch from speakerphone to handset mode.

Microphone (Mic/Mute) Button

This button toggles between Mic and Mute. When Mic button is lit, handsfree communication is supported, when Mic is pressed again and light is off, Mute is enabled and mutes both the microphone and the handset.

Hold

- To place a call on hold, press . Your LCD shows the line on hold. The held Line's LED flashes green while appearances of the line at other stations flash red.
 - To return to the held call, press the flashing held Line button.
 - If you do not return to the held call within a specified time, it rings back to your telephone. The call remains camped-on to your station.
 - If the held party hangs up, the call is released.
 - See the Call Pickup section to pick up a call on hold from another extension.

Exclusive Hold

This feature enables you to place a call on hold so that only you can retrieve it.

- While on a call, press  twice. That line's LED flashes green while appearances of the line at other stations are steady red (in use).

Automatic Hold

This feature enables you to move from one Line button to another Line button without pressing Hold.

Check with your System Administrator to make sure this setting is turned on. If Automatic Hold is not enabled, calls will drop when moving from one line to another without pressing Hold.

- While on a call, press another extension button to receive/originate a new call. The accessed line's LED flashes (in-use). The first call is put on hold and your extension's LED flashes.

Consultation Hold

1. While on a call, press . The call goes on hold.
2. Dial another line.
3. Transfer the call or return to the held call by pressing its Line button.

LED Indicator Details

Each line and Programmable Feature Button has a LED next to it which indicates the status of the line or feature associated with the button. Line LEDs light red or green and flash at varying rates to indicate call status (see [Table 6](#)).

Table 6 LED Indicators

LED	Your Station (Green)	Other Station (Red)
	Interval Rates	
Extension In-Use (access outside line)	2 seconds On, 1/8 second Off — 1/8 second On/Off	steady
Incoming Call (while ringing)	1 second on at 10 pulses/ second —1 second Off	one second On/Off
Hold (outside line) If using Pooled Line Grp, the hold indication is only at the station that places the call on hold.	4 pulses/second for 1/8 second On/Off	1/2 second On/Off
Hold – Consultation (during consultation/transfer to another station)	10 pulses/second	steady
Hold – Exclusive (outside line)	10 pulses/second	steady
Hold – Recall (when held call recalls your idle station)	1 second at 2 pulses/second, 1 second at 10 pulses/second	flashes
Hold – Exclusive Recall	1 second at 2 pulses/second, 1 second at 10 pulses/second	steady
Internal Call (while station ringing)	Your extension button flashes 10 pulses/second—1 second Off	[SDN] red flashing or green ringing
Busy Station Transfer (outside call transferred to your busy station from a designated station or AA)	4 pulses/second, 1/8 second On/Off	3/4 second on, 1/8 second Off
After disconnecting first call...	10 pulses/second	2 pulses/second
Conference	10 pulses/second	steady

Note LEDs on the telephone flash at different speeds depending on the function performed. Flash rates can be found under [“LED Indicator Details” on page 24](#).

This chapter gives you more details about your DP5000-series telephone's advanced functions. An alphabetical list of supported features has been compiled in this chapter for fast and easy reference.

Account Code Calls

Account Codes (Forced or Voluntary) can be used for a variety of reasons including billing, tracking, and line restriction applications. Account Codes are assigned in the system as a fixed length (default is six digits) and are recorded by the system, along with the details of the calls, which can be printed on a Station Message Detail Recording (SMDR) report.

Verified/Non-Verified Account Codes

Verified Account Codes ensure that the system checks the account code you entered against a list created by the System Administrator. If the code is not in the list, the call will not go through.

Non-Verified Account Codes must be a uniform length but any digits are accepted.

Account Codes and Lengths are setup and managed by the System Administrator.

Forced Account Codes

Some applications require you to enter an Account Code. These Forced Account Codes may be verified or non-verified, depending upon the application, but in either case, the caller must enter a code before proceeding.

► To dial using Forced Account Codes

1. Place a call in the normal method.

If the call requires an Account Code, a burst of tone (Success Tone) is heard after dialling the telephone number alerting you to enter the Account Code.

2. Enter the account number.

When the number of digits designated for account codes has been entered, the number will be checked against the verified list, if chosen, and the call will continue as normal. If the number of digits entered for the account code is not reached or the verified code does not match, then re-order tone is heard and the call is rejected.

You can bypass Forced Account Code requirements with three emergency numbers, including 999 or 112. See your System Administrator for these numbers:

- 1) 999 or 112
- 2) _____
- 3) _____

Voluntary Account Codes (Verified/Non-Verified)

Voluntary Account Codes are optional. They can be entered during a call and are used for tracking selected calls using Station Message Detail Report (SMDR) call detail recording option.

If the system is set for Verified Account Codes, station users must enter a specific code when entering the Voluntary Account Code(s) or the code is not validated for the SMDR call report. This does not affect the call.

There are two ways to dial using a Voluntary Account Code:



► To dial using the Account Code button

Note This will require a Programmable Feature Button to be programmed on your telephone set with the Account Code feature (#46).

1. After accessing an Exchange Lines (CO), press the Account Code button. LCD telephones prompt you to “ENTER ACCOUNT CODE NOW.”
2. Enter the account code digits. The LCD prompt disappears upon entry of the first account code digit. After the account code is entered, the time indicator is restored to the LCD.
3. If your station is set for Verified Account Codes, you hear a confirmation tone when the code is valid. If the code is invalid, you hear two short tones.
4. Enter the Account Code. Your conversation is not interrupted.

► To enter an Account Code using access codes

Note It's a good idea to warn the other party that you will be disconnected momentarily when you enter the access code. Once the code is entered, you will be connected again.

1. After accessing an Exchange Line (CO), press . Once you press , your call is interrupted; you and the other party cannot hear each other. You will hear feature dial tone.
2. Dial #46. LCD telephones prompt you to “ENTER ACCOUNT CODE NOW.”
3. Enter the account code digits. The prompt disappears upon entry of the first account code digit. After the account code is entered, the connection is restored and the LCD shows the time.

Advisory Messages

Advisory messaging enables you to store an informative message for LCD telephones that call your telephone. The messages can be up to 16 characters long. The Strata system provides a number of predefined messages, shown in the table below. Message numbers 5~9 can be defined by your System Administrator.

Msg No.	Characters Displayed	Additional Digits
0	OUT TO LUNCH	
1	IN A MEETING	
2	CALL _____	Directory Number (e.g.,220)
3	BACK AT _____	Time (e.g., 1030)
4	RETURN ON_____	Date (e.g., 10 20)
5		
6		
7		
8		
9		

➤ **To set an advisory message**

1. Go off-hook or press your extension button to hear dial tone.
2. Press #411
3. Enter Message number (see table above)
4. Enter additional digits if required.
5. Go on-hook or press  to release the line.

➤ **To clear the registered message**

1. Go off-hook or press your extension button to hear dial tone.
2. Press #412.
3. Go on-hook or press  to release the line.

Alarm Notification Button

The Alarm Notification Button must be setup by your System Administrator on your station.

► **When the Alarm Notification button displays**

► Call your System Administrator.





This button stops displaying when the alarm clears or when you press the flashing button. If the alarm has not been cleared the Alarm Notification Button starts flashing every 10 minutes.

Automatic Busy Redial

After reaching a busy outside number, you can activate Automatic Busy Redial so that the system automatically redials the number at regular intervals. The system repeats the redial until the destination is no longer busy. Check with your System Administrator to see if this feature is setup for your telephone.

Automatic Busy Redial is not attempted while your station is busy, but continues to time-out. The system inserts a pause (P) on your LCD before redialing the number.

► **To activate Automatic Busy Redial**

1. When you reach a busy number, press Auto Busy Redial or  + #441. The LED flashes red. You hear confirmation tone.
2. Hang up or press . The system redials, up to five to 20 times, every 30 to 180 seconds (depending on system programming). Your telephone receives ring tone when Automatic Busy Redial dials the number and it is available. The extension and Spkr LEDs flash green.
3. Lift the handset or press  and wait for the party to answer. If you do not pick up the handset or press  within recall timeout (five to 60 seconds) after a connection is made, you hear a muted ring for another 30 seconds, then the call disconnects.

► **To cancel Automatic Busy Redial**

► Press Auto Busy Redial or extension + #442.

Automatic Callback

When you reach a busy station, you can set Automatic Callback to have the system monitor the busy extension and notify you when it becomes idle.

Automatic Callback can place you in queue for an available outside line, if you reach a line group in which all lines are busy. When a station or line becomes available, the system rings your telephone; when you answer the system automatically rings the intended destination. The amount of time the system will wait for an idle destination is set in system programming. Automatic Callback is also known as “CO Line Queuing.”

► To set Automatic Callback

1. If you hear busy tone after dialling an outside line access code or a station number, press Auto Callback or 4. Busy tone stops, followed by success tone, then busy tone resumes.
2. Hang up. You can make other calls while waiting.
3. When the called station or outside line becomes idle, your telephone rings and you will see a fast flashing LED.
 - If you called a busy station, the extension LED flashes green (incoming call) and the called number displays.
 - If you called a busy outside line, the extension LED flashes green (incoming call rate). The seized line's number displays.
4. Answer within about three rings (can be programmed to ring up to three minutes) to prevent the callback from being cancelled. After you answer, you hear success tone, and the LED flashes green (in-use).

If you hear a busy tone after answering a callback, the called party is already on another call or the line has already been seized or has received an incoming call. Your request is not cancelled. You will be called again the next time a line becomes idle.

If you were attempting to make an outside call, the telephone number is automatically dialled, including the account code or override codes that were used.

► To cancel ACB

- Press Auto Callback or extension button + #431.

Background Music

You can set background music over your telephone speaker or over external speakers. At least one music source must be connected to your system. Up to 16 different music sources can be applied to the Strata CIX/CTX system: the first source is Quiet Tone, all others can be music or recorded information.

➤ **To enable background music on your telephone speaker**

➤ Press BGM. LED turns on.

Or press an extension button + #490 + n + #, where n is the music source 1~15.

➤ **To cancel background music on your telephone speaker**

➤ Press BGM. LED turns off.

➤ Or press an extension button + #491.

➤ **To change the BGM source (1~15) assigned to the BGM button**

Press an extension button + #9876 + BGM + n + BGM, where n is the music source 1~15.

➤ **To enable background music over your external paging speakers**

Press an extension button + #492 + n + #, where n is the music source 1~15.

➤ **To cancel background music over your external paging speakers**

Press an extension button + #493 +  .

Call Forward

There are two types of Call Forwarding that you can set. One is System Call Forward (set in System Programming) which automatically directs calls to a predefined location, such as Voice Mail. See your System Administrator to determine or change your System Call Forward destination.

The other type is Station Call Forwarding. You can use Station Call Forwarding to replace your System Call Forward destination with a custom Call Forward setting made from your station.

System

System Call Forward directs calls to a destination preset by an Administrator for each telephone, commonly set to voice mail.

- To turn on System Call Forward for your telephone, press #620. Confirmation tone (three short tones) and display shows “DATA PROGRAMMED.” This indicates the data is set.
- To turn off System Call Forward for your telephone, press #621. Confirmation tone (three short tones) and display shows “DATA PROGRAMMED.” This indicates the data is set.

Station

Station Call Forward enables you to assign Call Forward destinations for each extension on your telephone that will override the telephone’s System Call Forward settings. Each extension can be independently setup to Station Call Forward to a unique destination. You can set a Programmable Feature Button to perform any Call Forward function - see [“Programming Feature Buttons” on page 84](#) for more details. Call Forward must be set prior to receiving the call.

The following calls to your station can be forwarded:

- Internal calls
- Auto Attendant calls
- Outside lines that ring only your station
- Transferred internal or incoming line calls

Station Call Forward Categories

You can set Call Forward for the following categories of calls. Within these categories, you can use five different types of Call Forward Settings (as detailed in the next section).

- **Call Forward Any Call** – Forwards any call, whether an internal call or incoming line call.
- **Call Forward - Incoming Line** – Forward incoming line calls only.
- **Call Forward Any Call - Set for Another Station** – Enables you set forwarding of all calls for another telephone within your telephone system.
- **Call Forward - Incoming Line Set for Another Station**– Enables you to set forwarding of incoming line calls for another telephone within your telephone system.

Notes

- Call Forward Any Call and Call Forward-Incoming line can be set simultaneously on a telephone. This allows incoming lines calls to be forwarded to a different destination than all of the other types of calls.
- Call Forward destinations can be set to internal destinations or an outside telephone number.
- You can change your forwarding destination from outside the system using the DISA feature. See your System Administrator for DISA telephone numbers and security code access.

Call Forward Settings

- **Call Forward All Calls** – Forwards all calls immediately.
- **Call Forward Busy/Do Not Disturb** – Forwards calls immediately when your extension is busy or in Do Not Disturb (DND) mode.
In Tone-first systems with multiple lines, Call Forward Busy forwards calls only when all line appearances are in use. In Voice-first systems, Call Forward Busy forwards all calls any time your telephone is in use.
- **Call Forward - No Answer** – Forwards unanswered calls after a preset number of rings. The preset number of rings can be set on a per user basis.
- **Call Forward Busy/Do Not Disturb/No Answer** – Forwards all calls when you are busy, in DND mode or when you don't answer a call within a preset number of rings.
- **Call Forward Cancel** – Cancels the set Call Forward feature. Notice that each category of Call Forward has a different code for cancelling.

Station Call Forward Procedures

[Table 15 on Page 105](#) contains Call Forward Button sequences. You can do a Call Forward function by entering the button sequence as described or by programming a Programmable Feature Button to perform the sequence. See [“Programming Feature Buttons” on page 84](#) to program a Programmable Feature Button.

► To use the Call Forward button sequence

► Follow the instructions in [Table 17 on Page 110](#), shown under the “Button Sequence” heading. Some features require additional input, such as:

- **Dest. Ext. or Telephone No.** – Call Forward destination numbers can be internal extension numbers or outside telephone numbers. If the destination is an outside number, enter the access code used for dialling out (such as 9) + the telephone number + #. The CIX accepts destination numbers of up to 32 digits.
- **Timer** – Enter the number of seconds (08~60) your telephone should ring before forwarding the call. (This is the Call Forward-No Answer timer.)
- **Call Forward Pass Code** – A four-digit Call Forward pass code can be setup by your System Administrator and will allow one station to activate the call forward setting for another station. Users must enter the Call Forward pass code for the station to be forwarded.

Note In [Table 15 on Page 105](#), (tone) refers to three short tones used as a confirmation tone and will play at that point in the sequence to confirm your input was accepted.

Call Forward Examples

- ▶ **To set your telephone to Call Forward Busy-No Answer to an internal extension number**
 - ▶ Press your extension button + #6041 + 3000# + 10
 - #6041 = Call Forward Access Code sequence
 - 3000# = Internal Extension Number
 - 10 = Ring time in seconds before Call Forwards

- ▶ **To set another telephone to Call Forward Busy-No Answer to an outside destination number after a set time**
 - ▶ Press your extension button + #6042 + 1234 + 1111 + # + 9 + 44 207 168 9999 # + 08
 - #6042 = Call Forward Busy No Answer Access Code sequence
 - 1234 = Other telephone's extension number
 - 1111 = Call Forward Passcode for other telephone + #
 - 9 = Outside Line Access Code
 - 44 207 168 9999 = 44 + Area Code + Telephone Number
 - # = Must press after entering an outside destination number
 - 08 = Ring time in seconds before Call Forwards

Call Park Orbits

The Call Park feature enables you to hold a call temporarily in a location other than your telephone. These areas are called orbits. You or another telephone user can retrieve a parked call from its orbit by specifying the orbit number. You can specify one of 20 General Park Orbits (7000~7019) or a valid extension number within the system.

Once you have parked a call in an orbit, you can:

- Hang up and retrieve the parked call at a later time
- Originate another call
- Access a voice paging device to announce the parked call for pickup from another station

If you park a call and it is not retrieved, it will recall to the parking station and one of the following occurs:

- If your station is idle when the system Call Park recall timer expires, the parked call automatically recalls to your station.
- If your station is busy, the parked call camps on.

If you have an LCD telephone, you can let the system automatically select an available orbit number which displays on your LCD.

► To park a call

1. While on a call, press Park in Orbit or press  + #33. The LED flashes green (consultation-hold). If you were on an extension during the call, and you have line button on your telephone, the line LED will flash until the call is picked up (depending on programming).
2. Specify the Park Orbit using one of the following:
 - Press * and the system automatically selects a General Park Orbit between 7000~7019. The chosen orbit appears on the LCD.
 - Enter a valid extension.
 - Press # and the system automatically selects your extension as the orbit.
3. Hang up. The caller's extension or line number and the orbit number are shown. If the parked call is not retrieved within a specified time, the call rings back to your telephone. When a parked call recalls your telephone, the LCD shows the line or extension that is recalling and the orbit number.

► **To retrieve a parked call**

1. Press Park in Orbit or press your extension button + #32.
2. Enter the Orbit Number where the call is parked or # for the extension from which you are calling. You cannot use * to retrieve a parked call. The extension LED flashes at the in-use rate when the call is retrieved.

Call Pickup

You can pick up a call that is ringing another station's extension, a call placed on hold at another station and other types of calls. When you pick up an internal call, the calling station and the called station displays on your LCD.

Group Pickup

Two or more stations can be assigned to a pickup group, there are a total of 32 pickup groups available. You can easily pick up ringing calls on other extensions. Ringing calls include: new, transferred, internal, or external calls. You will have the ability to pick up calls for other extensions in your group and other groups as well. See your System Administrator for group assignments.

Ringing, Page or Held Call Pickup

This feature picks up ringing or held calls, including Group Page and All Call Page calls. If these types of calls occur at the same time, the pickup priority is station-to-station and then Page calls in the order of occurrence. In some systems, this feature can be applied to pick up All Call Page exclusively.

Feature Operations

Call Pickup

► To perform Call Pickup

► Press the buttons shown in the table below for the desired Pickup feature.

Table 7 Call Pickup Feature Codes

Ringing or Page Calls	To Pick Up:	Press Ext. Button, then dial the access sequence below:
Directed DN	A call ringing or held at the Extension Number.	#5#6 + Ext. No.
	A call Ringing, held or parked at the Ext. No.	#5#29 + Ext. No.
Group	A call ringing a member of your pickup group.	#5#34
Directed Ext.	A call ringing on any line of this Primary Ext. No.	#5#5 + Primary Ext. No.
Directed Group	A call ringing an extension in this Pickup Group.	#5#32 + Group No.
Ext. No.	A call ringing this Ext. No. only. Other lines ringing on the same phone are unaffected.	#5#22 + Ext. No.
Outside Calls	Any incoming outside line call.	#5#9
All Call, Group, and/or External Page	An All Call Page, Group Page and/or External Page by Page Zone or by a specific Ext. No.	#5#36 + Page Zone No. (01~08)
		#5#5 + Ext. No. of another phone being paged.
Held Calls	To Pick Up:	Press Ext. Button, then dial the access sequence below:
Local Retrieve	A call held on this telephone.	#5#71
Remote Retrieve	A call held on another Primary Ext. No.	#5#72 + Primary Ext. No.
Outside Line Retrieve	A call held on this outside line only, regardless of the phone that placed the call on hold. Must enter a three digit outside line no. (e.g., 007).	#5#73 + Outside Line No. (001~128)
Directed Ext. Retrieve	A call held on for this Ext. No., regardless of where this Ext. No. appears.	#5#74 + Ext. No.

Notes

- The Primary extension number is the directory number by which the telephone set is defined. Other, non-primary extension numbers may also appear on the telephone. By convention, the Primary extension number is assigned to the first button (on the bottom left-hand side) of a multi-button telephone.
- If more than one call is on hold, the call on the telephone's lowest button number is picked up.
- Ringing calls are picked up over held calls as a priority.

Call Transfer

Call transfer allows a call to be directed from one telephone to another on the CIX. External transfers to telephone numbers or network extensions off the CIX are also supported, please check with your System Administrator to see if this is enabled.

There are two types of call transfer:

- Blind transfer – The call is directly transferred to another extension without announcing the call or waiting to see if the caller is available.
- Supervised transfer – The call is “supervised” during the transfer process so the call can be announced to the receiving party before completing the transfer. A supervised transfer also allows the person originating the transfer to take back or cancel the transfer.

► To perform Call Transfer Immediate

1. While on a call, press the **TRNS** Soft Key.
2. Dial the extension where you wish to transfer the call. The call rings the destination station and your telephone returns to the idle state. If your telephone does not go idle, the destination may be located in a remote node, so you need to hang up to return to idle state.

► To transfer using the button

1. While on a call, press . Your Line LED flashes green and you hear internal dial tone.
2. Dial the extension where the call will be transferred. You can remain on the line and announce the call or hang up to complete a “blind transfer.”

Note If the privacy option has been disabled, then if you use a Line button when you transfer the call, the LED will flash red until the receiving party answers. While the LED is flashing, you can press the Line button to return to the call. If the receiving party answers the call, the LED turns solid red and you cannot reconnect to the original caller.

During call transfer, you can connect all three parties by pressing the  button or by pressing the JOIN soft key. This allows the three parties to talk together.

3. Transfer with Camp On: If the station to which you want to transfer the call is busy, you may hang up and the transferred trunk or station will be camped on to the busy destination.

► To transfer a call directly to Voice Mail (VM)

1. While on a call, press .
2. Enter #407.
3. Enter the VM mailbox number (usually the same as the extension number) + #.
4. Hang up and the caller is connected to the VM mailbox. This feature does a blind transfer to VM.

► To transfer a call directly to VM with a DSS button

1. While on a call, press .
2. Press the DSS button programmed to the voice mail number.
3. Hang up and the caller is connected to the VM mailbox.

Call Waiting

You can answer a call that is transferred to your station, even when your station is busy. When another call is camped onto your station, you hear two Camp-on tone beeps and the extension or Line LED flashes red (on-hold).

If a call is sent to your station when busy, and your station does not have an extension button available to receive the call, two camp-on tone beeps are sent to your telephone. You must disconnect or transfer the existing call to answer the waiting call.

► To answer a waiting call by placing the current call on hold

- Press . The existing call is placed on hold. The camped-on line rings your station (the Line LED flashes green - incoming call)...or if your telephone has the Auto Hold feature, just press the flashing extension button.

You are connected to the transferred call. The extension or Line LED flashes green (in-use).

Note See your System Administrator to find out if you have Auto Hold.

► To answer a waiting call by disconnecting or transferring the current call

- Hang up or transfer the existing call; the camped-on call rings your station. The camped-on line rings your telephone and the Line LED flashes green (incoming call). ...or press the flashing extension or Line. The existing call is placed on hold. The camped-on line rings your station (the Line LED flashes green - incoming call). This disconnects the current call and connects you to the transferred call. The extension or Line LED flashes green (in-use).

Caller ID

Incoming calls to your extension with Caller ID can be recorded into a rolling list that is saved on your telephone. The call information is placed in the list along with the number, name (if provided), time and date of the call, and status of the call (answered, abandoned, or redirected). You can access this list from an LCD telephone with a flexible Caller ID button.

► To view saved Caller ID information



1. When your station is idle, press the Caller ID button.
The Caller ID LED lights green and the latest record displays.
2. Use the soft keys (Next, Prev, Call or Exit).

Note Caller ID is displayed when a call is first answered and will be displayed for the first 15 seconds of the telephone call.

Conference Calls

You can conference together up to eight parties (including yourself) - with up to six parties being external network lines. The actual number of conference parties with acceptable volume levels depends on the local and far end telephone line conditions. The person who initiates the conference call is the Master. If, after the conference is established, the Master exits the conference, the first station to have been added to the conference becomes the Master.

► To conference calls

1. While on a call, press . You hear dial tone and your Line LED flashes green.
2. Call another station or outside line.
3. When the called party answers, press . If you receive a busy tone or no answer, press  again to return to the original connection.
All parties are conferenced. If the second call was placed on a Line that appears on your telephone, the LED also flashes green.
4. Repeat steps 1~3 until all parties are added or the maximum number of parties is reached.

Note When the Master of the conference hangs up, the control is automatically transferred to the first internal station added to the conference call. If no other internal stations are included in the conference call, the call will be disconnected.

► To transfer conference control

1. Complete Steps 1 and 2 above to add the line to which you wish to transfer conference control. See previous Note.
2. Announce the call and hang up to transfer it. This station now becomes the conference Master with the ability to add or delete parties.



► To hold a conference call

- If you are the Conference Master, press the  button once (or twice for Executive Hold) to place the conference call on hold. The other parties can continue with the conference. Music-on-hold is suppressed and your extension LED flashes green. You can rejoin the conference at any time by pressing your extension button. When you return, you retain Master status.

Adding Voice Mail to a Conference



The Conference Master can add voice mail to a conference. This feature enables participants in a conference to listen to or leave a voice mail message during a conference call.

► To add Voice Mail to a conference call (performed by Conference Master)



1. Press  to place the current call on Consultation Hold.
2. Dial the voice mail (VM) extension number, then enter the VM mailbox and security code. This adds the voice mailbox to the conference.
3. Press  to reconnect to the original party. (You can continue to add conference members by pressing  and dialling another extension.)

Now, all parties in the conference can listen to or record a message to this voice mailbox. Only the Master can control the VM with touchtones or Soft Keys.

Supervising a Tandem Call

1. While talking on an outside call, press . You hear dial tone. The extension LED flashes (conference rate).
2. Dial an outside telephone number.
3. After the party answers, press . The extension LED flashes (in-use rate) and all parties are conferenced.

If you receive a busy tone or if the station does not answer, press the flashing extension button to return to the original connection.

4. Press  and hang up. The extension LED flashes (exclusive-hold rate) and the two lines are connected. The LED turns Off when the parties hang-up.
5. To supervise a tandem call, press the extension button. If the parties have finished, hang up...or if the parties are still talking, press  and hang-up. Both Line LEDs turn Off and the connection is released.

If your telephone company provides automatic disconnect supervision, the connection will release automatically when the parties hang up. If not, the lines must be supervised to be disconnected.

Conference Add/Split/Join/Drop



If you initiate a conference with two or more parties, you can continue to add outside callers to conference; or you and another member of the conference can leave (Split) the conference for a private conversation. During this time, other conference members remain connected.

You can then Join both of you back into the conference, or you can Drop (disconnect) the member you are connected to. This feature is performed with Soft Keys if you have a LCD phone or with a Split button programmed on one of your Programmable Feature Buttons.

This feature also works for remote stations which are connected through Strata Net QSIG.

Important! *You must be a conference master to perform the Add, Split and Drop features. The conference master is the person that initiates the conference call. If that person drops from the conference, the first person added to the conference becomes the conference master.*

► To add an Incoming call to the Conference

1. Place the first caller/Conference on hold.
2. Answer the incoming ringing call.
3. While speaking to the incoming caller, press  button.
4. Press the blinking DN where the first caller/Conference was placed on hold.
5. Press  twice to join all parties together.

► To Split from a conference

1. While in a conference call on a DP5000-series phone, press the **SPLT** (Split) soft key or Split button.
2. Press the **NEXT** soft key until you see the extension number for the party that you want to Split out of the conference.
3. You can return both yourself and the other Split party back into the conference by pressing **JOIN**.

RTRN terminates a feature operation and returns to the previously displayed state.

► To Drop the Split party from a conference

- Press the **DROP** Soft Key. The party that you are talking to privately (the party which you have Split from the conference) will be disconnected (Dropped) and you will rejoin the conference.

If you are in a three-way conference and Split with one of the parties, the remaining party will essentially be “on hold” until you return to the conference.

Direct Inward System Access (DISA)

Outside callers with touch tone telephones can call in to lines programmed for Direct Inward System Access (DISA) and dial an extension or outgoing line without going through an attendant or operator. Check with your System Administrator to see if this feature is available for your telephone.

1. From outside the system, dial the public telephone number assigned to DISA. The call will be answered and you will hear system dial tone.

If you do not dial within 10 seconds, the line disconnects.

2. When you hear dial tone, dial an extension or an outside line.
3. If you dial an outside destination, you may need to enter a security code provided to you by the System Administrator. When you hear the tone, enter the security code. If accepted, the call will proceed.
4. If you receive busy tone and you want to dial another number while the station is still ringing, press * and repeat Step 2.

Direct Station Selection Buttons (Hotline)

This optional feature enables you to use a DSS button to connect directly to another station's line extension. The DSS LED shows the status (idle/busy) of the station and/or the station's primary extension. For example, a station's DSS button LED shows busy (light steady red) when the station is:

- busy on a call on any button
- idle but all appearances of the station's extension are in use by other stations.

When the station is in DND, the LED flashes red.

► To connect directly to another station's extension

1. When connected to a line or another station, press DSS.

The original party is put on-hold. You can call a station even if the DSS LED shows busy (steady red).

2. Announce the call...or transfer the call by hanging up or pressing Release.

Note You can transfer the call to an idle or busy station.

Do Not Disturb

If your station is in Do Not Disturb (DND) mode, internal, external and transferred calls do not ring your station and Off-hook Call Announce calls are denied. You can continue to make calls while in the DND mode. When originating a call in DND mode, you will hear a short burst of interrupted dial tone followed by continuous dial tone. You can start dialing at any time during either tone.

If you put your Primary extension into DND mode, all calls to that telephone are rejected. If your extension is set for Call Forward-Busy or Call Forward-Busy/No Answer, the call is redirected to the forwarding destination immediately.

If you put an extension other than the Primary extension into DND, only calls to that extension on your telephone will be blocked. Appearances of that extension on other telephones continue to ring.

➤ **To activate DND on your Primary extension**

➤ Press Do Not Disturb or #6091 (hear Success Tone). The LED lights steady red and DND mode is activated for the entire station.

➤ **To activate DND on a non-Primary extension**

➤ Press the desired extension appearance and Do Not Disturb or #6091 (hear Success Tone). The LED lights steady red and DND mode is activated for that extension on your telephone.

➤ **To deactivate DND**

➤ Press Do Not Disturb or #6092 (hear Success Tone). The LED lights goes out and DND mode is de-activated.

Setting DND for Another Extension

➤ **To activate DND for another extension**

- Enter #6191 (hear Entry Tone) + the Primary extension of the remote extension + the pass code + # (hear Success Tone). This sets DND as if activated by the Primary extension on the target telephone.

➤ **To deactivate DND for another extension**

- Enter #6192 (hear Entry Tone) + the Primary extension of the remote extension + the pass code + # (hear Success Tone). This removes DND from the target telephone.

➤ **To change your DND Pass Code**

- Enter #670 (hear Entry Tone) + ext. no. (hear Entry Tone) + old pass code + # (hear Entry Tone) + new pass code + # (hear Success Tone).

If you activate DND while a call is ringing, the ringing stops. The LED continues to flash on your telephone and ring on other appearances.

Door Lock(s)

If you have locked doors in your facility that can be controlled through the Strata CIX system, you may be able to unlock these doors by using your telephone's Unlock Door button(s). The Unlock Door button(s) is programmed to unlock a specific door. Check with your System Administrator to find out the locations of your system's door phones and record them below.

Door Lock No.	Location
0	
1	
2	
3	
4	
5	

Door Lock No.	Location
6	
7	
8	
9	
10	

➤ **To unlock a door**

- Press the specific Unlock Door button or #12 + the Door Lock Number (see above table). The door unlocks for three~30 seconds (set in system programming). The Unlock Door LED is lit while the door is unlocked.

Door Phone(s)

Door phones can be used to call phones selected in system programming. When a door phone calls, you hear a distinctive ringing tone, one or five times (set in system programming). You can also call a door phone and monitor the surrounding area.

LCD telephones display the door phone name ID when calls are made to or from door phones.

The number of possible door phones varies by Strata CIX system, 01~24 maximum for larger systems. Check with your System Administrator to find out the names and locations of your system's door phones and record them below.

Door Phone	Name/Location	Door Phone	Name/Location

➤ To answer a door phone call

- When you hear a door phone call ringing, lift the handset or press the ringing button. A door phone call sounds like chimes (high/low). The extension LED flashes green (in-use) and you are connected to the door phone.

...or to pick up door phone calls ringing someone else's telephone, press your extension + #5#5 + directory number of the ringing phone.

► **To call/monitor a door phone**

1. With the handset off-hook, press an extension button. You hear dial tone and the LED flashes green (in-use).
2. Press #15 (hear three tone bursts), then enter the door phone number (01~24, depending on system size). A two-way talk-path exists between your telephone and the door phone. The door phone will not ring. You can audibly monitor the area around the door phone.

► **To call from a door phone**

1. Press the door phone button and then release it. You hear a distinctive ringing tone—one or five times (set in system programming).
2. When answered, speak at a normal voice level in the direction of the door phone.

Emergency Call

- To make an emergency call, dial 999/112 or Access Code + 999/112. This depends on off-hook preference set up for your telephone.

Note Check with your System Administrator for the Access Code because this code may be different from the one used to get an outside line.

Emergency Monitoring Station

Your system may have one digital telephone assigned as an emergency monitoring station. If your telephone has this assignment, your line LED will flash green when someone makes a 999/112 call. When you answer the call, you can listen in and participate in the conversation. See your System Administrator for more information on this feature.

Emergency Ringdown

If a station remains off-hook for a programmable period, it can be automatically treated as an Emergency Call and directed to an emergency destination. The station may have partially dialed a number or have dialed no digits at all. Each station is programmed with its specific emergency ringdown destination.

A station number or a group pilot number can be specified as an emergency ringdown destination. In a private network, the station or pilot number must be in the same network node. Remote emergency destination and door phones are not permitted.

Language Codes

This feature enables you to change the language sent from the Attendant Console or from a PC. See your System Administrator to find out if your telephone is programmed with the ability to change languages.

► To change the Language Display

► Enter the Change Language access code #495 + the Language Code (see below).

1: English date format – **MM/DD (YY)**

2: British English – **DD/MM (YY)**

3: French – **DD/MM (YY)**

4: Spanish – **DD/MM (YY)**

Message Waiting

Message Waiting is shown on the  button which will flash red when there are messages waiting. The waiting message indicators can come from the voicemail system or they can be internal messages sent from other extensions.

The messages from other extensions are notifications that someone has called your extension and wants you to call them back.

An extension can receive up to three Message Waiting indications, one additional indicator will always be reserved for the voicemail system.

Note If there are Phantom DN's (PhDN's) programmed on an extension, each PhDN can receive up to three message waiting indicators.

► Responding to a Lit Msg LED

1. Press Red flashing  button. The telephone will dial the message source (the voicemail or another extension). See Note below.
 2. When call is finished, hang up and the message waiting indicator will be cleared.
 3. If the Msg LED continues to flash, there are additional messages to check, repeat steps 1-2.
Voicemail devices have a short delay in turning off the message waiting indicators.
- To manually turn off the Msg LED, press your extension button, then enter #409. Repeat this sequence until all the messages are cleared.

Notes

- If there is a + on the LCD, press the Next Soft Key to scroll through the messages sent to that extension.
- To see who has sent you messages, or to retrieve the messages, press the flashing  button.



Turning On/Off MW LED on Another Extension

When an extension is called, the calling party can choose to send a message to the called party. This is a notification to say that a call has been missed and the calling party would like to be called back.

By sending a message to another extension you turn on their Msg LED.

1. Dial an internal extension. You may hear ringing or busy tone.
2. Press  or 7. The Msg LED flashes red on the called telephone. At your telephone, the Msg LED lights steady red and the LCD shows the station number where the Message Waiting light was sent to.

If you decide to cancel the Message Waiting light at this point, press  or 7 again while ring-over tone is playing and the light will be cancelled, or if you want to cancel the message later, call the telephone you set the message on and press 7 twice.

3. Press . Your Msg LED turns Off. The Msg LED on the called telephone flashes until the called party presses the flashing  button which calls you back.
4. Turn off the Message LED.

► The two ways to turn Off a Message LED are

Method 1

1. Press #64 plus the extension number that has the message light set.
2. Press  or hang up to end the call.

Method 2

1. Dial the extension that has the Message LED on.
2. Press 77
3. Press  or hang up to release your telephone.

Microphone Cut-Off

This feature prevents callers from monitoring the sounds near your telephone when your telephone receives a Handsfree Call or cuts-off the telephone microphone while on a speakerphone call. When the feature is ON, the Microphn Cut-off LED lights steady red and the Mic and Spkr LEDs do not light when your telephone is called. When the feature is OFF, the Microphn Cut-off LED is not lit and your microphone works. The Microphn Cut-off functions on Handsfree Answerback and speaker OCA calls for privacy.

- **To turn the microphone ON/OFF**
 - Press Microphn Cut-off to toggle between ON/OFF.

Off-hook Call Announce

Off-hook Call Announce (OCA) enables you to complete a call to a *busy* digital telephone. Your telephone must be programmed to either announce automatically or to announce after you press a button on your dial pad. The destination telephone must be programmed to accept an OCA. The announcement may be delivered over the handset or the speaker.

Handset OCA can operate on any digital telephone. Speaker OCA requires the addition of a special circuit board inside the speakerphone.

► To make an OCA call

- **Manual** – Dial an extension. When you hear busy tone, press 5 and, after one long tone, you can talk through the speaker of the destination telephone. The person you are calling has answering options described below.
- **Automatic** – If your telephone and the extension you are calling have been programmed for Automatic OCA, you can talk through the speaker of the destination telephone without hearing the busy tone and without dialling 5.



► To answer a Handset OCA call

While you have a call in progress, you hear one tone in your handset to indicate that a second station is calling.

- Press  to toggle between the new and original callers.

You talk to the new caller for as long as you hold down . When you release the button, you return to the original caller. In both cases, neither caller can hear the other. Your LCD indicates which station or Exchange line (CO) you are connected to.

► To answer a Speaker OCA call

1. While you have a handset call in progress and you hear one tone, this indicates that a second station is calling. The second caller connects to the speaker in your telephone. The Spkr LED flashes and the Mic LED lights. You will be speaking to the first caller through your handset and the second caller through the microphone.
2. To turn off your microphone speaker to the second party, you can press  or Microphn Cut-off; the Mic LED turns Off. You will no longer be talking to the second caller, although he/she can still speak through your speaker.
3. Press  or Microphn Cut-off again to reconnect to the second caller. You can toggle as often as you choose. If you do not want the first caller to hear your conversation with the second caller, cover the mouthpiece of your handset.

Override Calls

The available override features are:

- Busy Override
- Do Not Disturb Override
- Executive Override
- Destination Restriction/Traveling Class Override
- Class of Service Override
- Privacy Override

Busy Override

Ring Over Busy Override enables you to send a muted ring tone to a busy station to indicate a call is waiting. The Busy Override (BOV) muted ring can be programmed for each station to be two muted rings only or continued muted rings until the call is answered. This option applies to the station receiving the muted ring. The muted ring can be sent to the telephone speaker or to the telephone handset/headset and speaker.

► To use Busy Override

- After reaching a busy station, press 2. A muted tone is heard at the busy station, indicating that a call is waiting. The station number displays.

Do Not Disturb Override

Do Not Disturb (DND) Override lets you send a call waiting tone or ringing to a station in DND mode to indicate that a call is coming in. Your telephone may be programmed to block DND Override from other telephones. Your station's LCD shows the station you have called is in the DND mode.

OCA is possible to DND stations from stations that are programmed for DND Override.

► To use DND Override

- After reaching a station in DND mode, press 2. A tone signal is heard at the DND station, indicating a call is coming in. On your station, the LCD shows the station number you have overridden.

Your LCD displays **DND OVR DENY**, if the station you called denies DND Override.

Executive Override

Executive Override enables you to enter an established conversation. Your telephone can also be programmed to block Executive Override from other telephones.

► To perform Executive Override

► After reaching a busy station, press 3

...or, if you have an LCD telephone, use the **OVRD** Soft Key.

You enter a conference with the busy station and the party to whom he was talking. The called parties may hear an optional tone signal prior to your entering the conversation.

Your LCD displays **EXEC OVR DENY**, if the station you called denies Executive Override. If you do not have Override privileges, you will camp on.

Destination Restriction/Traveling Class Override

Enables a station user to override the Destination Restriction or Travelling Class of a particular telephone by entering a pre-determined account code.

► To use Destination Restriction or Traveling Class Override

1. Press 471. Confirmation tone plays and the LCD shows “Enter OVR Code.”
2. Enter the trunk access code or LCR access code.
3. Dial the external telephone number.

Class of Service Override

By dialling a Class of Service (COS) Override code, a user can change a station’s set of privileges to one associated with the override code. When the call is terminated and another is attempted from the same station, the original COS is applied. This allows selected users to override restrictions that are placed on any telephone in the system.

► To perform Class of Service Override

1. Access a Primary or Phantom DN. You hear dial tone and the LED flashes at the in-use rate.
2. Press #471. Dial tone stops. Your LCD prompts you to enter a code.
3. Enter the COS Override Code (four digits). You hear dial tone.
4. Dial a telephone number.

Note For security reasons, the override codes are only available on a selected basis. See your System Administrator.

Privacy Override

This feature enables you to enter an established call on a line you share with another telephone. Up to two station users can enter an existing Exchange (CO) line-to-station call (i.e., up to three stations can be connected to an Exchange line). You can also use this feature if the station that is already connected to the exchange line is in the Privacy Release mode.

Station users with Privacy Release can allow stations with the shared button appearance to enter their conversations, even if the station entering the conversation is not programmed for Privacy Override. (see [“Privacy” on page 59.](#))

Paging

Station users can make page announcements to telephones and external speakers. Check with your System Administrator to find out the zone numbers for various paging groups.

- ▶ **To make a Page Announcement to telephones or external speakers**
 1. Lift the handset, press your extension button and enter a paging access code.
 2. Make your announcement, then hang up.
- ▶ **To make a Group Page**
 - ▶ Press Group Page and enter the Group number (01~16)
...or press extension + #31 and enter the zone number.

Answering a Page

- ▶ To answer a Group Page, lift the handset off-hook, dial #5#36 and enter the Page Zone number (01~08, depending on your telephone system).
- ▶ To answer an External Page Zone, lift the handset off-hook, dial #5#36 and enter the Page Zone number (01~08, depending on your telephone system).

All Call Page

You can make an All Call Page to telephones assigned to the “All Call Page Group.” Stations are assigned to the “All Call Page Group” in system programming.

► To make an All Call Page

1. With the handset off-hook, press All Call Page
...or dial #30. This pages all telephones in the All Call Page Group but, depending on system programming, you may or may not page external speakers.
2. Make your announcement then hang up.

► To answer an All Call Page

1. Lift the handset off-hook, dial #5#36.
2. Enter the Page Zone Number (01~08, depending on your telephone system).

Emergency Page

An Emergency Page overrides Group Pages or All Call Pages to telephone and external paging devices.

- To make an Emergency Page, lift the handset off-hook, dial #37.
- To make an Emergency Page to a group, lift the handset off-hook, dial #38 and enter the Group number.

Privacy

Privacy controls the ability of more than one person to use the same extension or Exchange line at the same time. Privacy applies to multiple appearances of extensions, Phantom extensions, outside Lines and outside Line Group buttons. The application of Privacy to individual telephones is controlled in system programming.

By default, the system is private. If you are in a conversation, another telephone with an appearance of the line on which you are talking cannot intrude unless that telephone has been programmed for Privacy Override. In that event, the other telephone may enter and leave the conversation at will. If all users are provided with Privacy Release in Class of Service, the system will function as non-private.

Your telephone may be equipped with a Privacy Release and/or a Privacy on Line button. On a normally private telephone, Privacy Release allows other appearances of you line to join the conversation. On a normally non-private telephone, Privacy on Line allows you to exclude others. The Privacy condition may be toggled at any time during a conversation. At the end of the conversation, the line's privacy condition returns to its original state.

➤ To use Privacy Release

➤ While on an Exchange line call, press Privacy Release. The LED lights red. The outside line flashes at all appearances. When another station user enters the outside line call by pressing a common outside Line, the Privacy Release LED turns Off. To add a third station, press Privacy Release again; the process repeats.

➤ To set/cancel Privacy

➤ Press Privacy on Line to set privacy. The LED lights steady red. Others are blocked from entering your outside line calls when they press a common Line ...or press Privacy on Line again to cancel the feature. The LED turns Off.

Redial

Use this button to redial the last number dialled from your telephone.

➤ To redial the last number, press Redial or *0.

Speed Dial

Speed Dial (SD) enables you to dial a sequence of up to 32 digits with a shorter code. Dial sequences can include telephone numbers, authorisation codes, passwords feature activation codes and pauses. Speed Dial may be used to originate a call or invoked after a call is established. There are two types of Speed Dial:

- **System SD** – All telephones in your system can share a list of up to 800 System Speed Dial numbers under the exclusive control of the System Administrator. In some cases, System Speed Dial enables you to reach numbers that you would not be allowed to dial directly from your telephone.
- **Station SD** – Your System Administrator allocates a block of up to 100 personal SD numbers (10 per telephone). You have exclusive use of them and you can create and change them from your own telephone. If you have a 9-Line LCD telephone, you can assign names to your station SD numbers to appear on the Personal SD Directory display (see your System Administrator or use the procedure for [“Storing Personal Speed Dial Names” on page 63.](#))

► To use personal Speed Dial

1. See your System Administrator to check how many personal Speed Dial numbers are allocated to your telephone and if you have Speed Dial capabilities enabled on your telephone.
2. Setup / Store your personal Speed Dial numbers.
3. Assign names to personal Speed Dial numbers (on supported models).

Making a Call Using Speed Dial

There are two ways to begin a Speed Dial Call.





1. Press  on a DP5000-series digital telephone ...or press the * button on any telephone.
2. Dial the Station or System Speed Dial Number. Station Speed Dial numbers occupy numbers 100~199. System Speed Dial numbers occupy numbers 200~999.

Table 8 Speed Dial Access Codes

Feature	Feature Access Code Sequences
Speed Dial (Dialling an SD number)	
Station ¹	 ² + nnn nnn = 100~199 Station SD numbers
System ¹	 ² + nnn nnn = 200~999 System SD numbers

1. Stations must be assigned/enabled Speed Dial capabilities in system programming by an Administrator in Program 200-30 (System SD) and Program 200-35 (Station SD).
2. If your telephone does not have a  button, press the * button, then dial the three digit Speed Dial bin number (nnn).

Storing a System/Station Speed Dial Number

1. Dial #66. The display shows “SPEED DIAL” and you hear Entry Tone.
2. Dial the Station Speed Dial number (100~199) or System Speed Dial number (200~999). The LCD shows your digits and you hear Entry Tone.
3. Dial the telephone number to be stored + #. Include any required access and area codes. The LCD shows “SPEED DIAL” + the Speed Dial Number + destination + #. You hear Success Tone.
4. Lift handset.
5. To enter another number repeat steps 1-4. Refer to [Table 9](#) below.

Example: To store a Station Speed Dial number to Speed dial location 100, dial #66 + 100 + 99495833000 + #

Table 9 Feature Access Codes

Feature	Feature Access Code Sequences
Speed Dial (Storing an SD number)	
Station ¹	#66 + nnn + Phone No. ² + # nnn = 100~199 SD bin numbers
System ¹	#66 + nnn + Phone No. ² + # nnn = 200~999 SD bin numbers

1. Stations must be assigned/enabled Speed Dial capabilities in system programming by an Administrator in Program 200-30 (System SD) and Program 200-35 (Station SD).
2. Refer to [Table 10 on page 62](#) to see how to enter * and # into a speed dial phone number.

Advanced Speed Dial Operation

Special Characters

SD numbers may include 0~9, #, * and Pause. For an example on how to use special characters, see [page 87](#).

Table 10Phone Number Dial String Characters

Entry	Meaning
0~9	0~9
#	End of Speed Dial Number when entering via access code (#66)
*	Escape. “*” functions as an escape key indicating that the number immediately following represents something exceptional. When * is used as an escape character, it consumes one Speed Dial digit. Entering *7 to insert a seven-second pause would use two of 32 characters.
* (1 ~ 9)	A pause from 1~9 seconds. To pause longer than 9 seconds, enter more pause escape sequences. Example: To insert a 17-second pause, press *9*8. A “P” displays denoting a pause in the SD number. In this example, you would see “PP.”
**	* is entered into the speed dial string.
*#	# is entered into the speed dial string.

Long SD Numbers

Up to 32 digits can be stored in one SD location. If you exceed 32 digits, the excess digits are automatically stored in the next sequential SD location. If SD 100 contains 40 digits, then 8 of those digits would be stored in SD 101. If you save other digits to SD101 they will over-write the eight digits automatically stored there.

Storing Personal Speed Dial Names

You can store names with Personal Speed Dial numbers. These names will display as Soft Keys, that can be used for dialing from the telephone LCD directories.

Notes

- Speed Dial locations must be assigned to your telephone by your System Administrator before you can store names. Your System Administrator can also associate names with Station Speed Dial numbers.
- Only the Administrator telephone can store System Speed Dial numbers.

► To assign Station Speed Dial names

1. Enter User Programming Mode by dialing #9876 or, press Program.
2. Press . "SPEED DIAL MODE" displays on the LCD.
3. Enter a Speed Dial location number (100~199 for personal speed dial or 200~999 for System speed dial, depending on system programming).

4. Enter the telephone number to be stored. If you normally a dial line access code (such as 9) and/or and area code, enter the codes before the telephone number.



Example:

Press the  for "A."

Press the  again for "B," etc.

Refer to the table for other characters.

5. Press , then input the name that will appear in the Personal SD directory (nine characters max).

You can enter alphanumeric characters from the dial pad (shown right and in [Table 11](#)).

Notes

- To store #, press *#
- To store *, press **

Feature Operations

Speed Dial

- To move one character to the right, press SCROLL or **RIGHT** Soft Key. To add a space, press the **RIGHT** Soft Key twice.
 - To backspace (delete previous character), press the PAGE or **LEFT** Soft Key.
 - To cycle back to the first letter, continue pressing the **LEFT** Soft Key.
6. Press . The Speed Dial name is now programmed.
 7. Go off hook. The telephone exits User Programming Mode.
 8. Test the Personal SD entry by pressing the **Personal SD** Soft Key. Look for the name in the entry and press the Soft Key associated with that name.

Table 11 Dial Pad Alphanumeric Characters

Dial Pad Buttons	Number of times to press the dial pad button				
	1	2	3	4	5
1	-	.	:	,	1
2	A	B	C	'	2
3	D	E	F	!	3
4	G	H	I	&	4
5	J	K	L	*	5
6	M	N	O	#	6
7	P	Q	R	S	7
8	T	U	V	?	8
9	W	X	Y	Z	9
0	()	&	/	0

Tone First / Voice First Signalling

To determine the signalling on the telephone circuit.

Tone First Signalling

When the telephone rings and the called party must press  or lift the handset in order to receive the call.

Voice First Signalling

The telephone does not ring when it is being called, rather a long tone is heard, followed by the caller's voice coming through the speaker. This method automatically starts in a hands free mode and allows both parties to speak with each other.

Note The calling party has control over whether Tone First or Voice First Signalling is being used. The ability to switch between the two is setup by the System Administrator.

- **To change the signalling method while placing the call**
 1. Enter the extension number
 2. Press 1 to turn on Tone First Signalling.
 3. Press 2 to turn on Voice First Signalling.

Tone/Pulse Dialling

With some older Exchanges, you may have to make calls on outside lines programmed for rotary dial pulses. This feature enables you, while on these lines, to switch to tone dial to access remote equipment (such as an answering machine) requiring touchtones.

Note With ISDN calls, when Tone Dial Select is pressed, all of the digits entered after that point will be sent with touchtones.

► To change Tone Dialling

1. Access an outside line.
2. Dial a telephone number.
3. While on the call, press Tone Dial Select. Although the outside line is programmed for rotary dial pulses, access the outside line and dial the telephone number like any other call described in this user guide.

The Tone LED lights steady red and you are able to send touchtones with your dial pad. The feature is cancelled when the call is completed.

Uniform Call Distribution

Uniform Call Distribution (UCD) provides ACD-like service based on the simplified Distributed Hunt feature. Incoming calls are answered by Voice Mail as the Auto Attendant function or they can be directly routed to the UCD (Distributed Hunt) Pilot number. The caller will dial the UCD Pilot station in response to a prompt. The call will go to the next agent or, if all agents are busy, the call will camp-on to the Distributed Hunt pilot and ring-back tone or Music-on-Hold (MOH) will be sent.

This feature distributes incoming calls to available agents. Agents must be logged into the group to receive UCD calls. The following illustration shows the typical call flow for this service.

1. Agent logs into the UCD group.
2. CIX receives a call from PSTN or extension.
3. The call is routed to voice mail which provides the initial greeting using the auto attendant service.
4. The voice mail can be configured to prompt callers to enter the destination number or to route the call to the pre-determined destination.
5. The voice mail transfers the call to the UCD pilot group.
6. According to the hunting rule (distribute), the call is delivered to an idle agent who logs in to this hunting group.

If no agent is available in the hunting group, the call is queued to the UCD pilot group. The caller may hear the Music on Hold (MOH) or Ring Back Tone (RBT) depending on the configuration. If the call cannot be answered within the preconfigured time, the call is routed to an overflow destination.

Login/Logout

Login and Logout is controlled by the Login key assigned to the agent phone (see *Strata CIX Programming Manual, Volume 1* for details). The Log status is displayed on the Login key as shown below

- **Login** - Key is On Steady
- **Logout** - Key is Off

The Login/Logout feature is applied to the call which terminates to UCD pilot only. Therefore, the call can terminate to agent Prime or Phantom PDN directly even if the agent is in Logout state. Also, Login/Logout can be activated by an access code. The default numbering plan is shown below.

Access Code	Feature
#6061	Login - from Agent Station
#6062	Logout - from Agent Station
#6161 + DN + #	Login - Agent Station (DN) from another station
#6162 + DN + #	Logout – Agent Station (DN) from another station
where DN = the Directory number of the agent station.	

This chapter provides an overview of the optional units that can be connected to the DP5000-series telephones (except the Single line telephone).

Add-on Modules

The following Add-on modules provide additional buttons:

- 10 Button LCD Module, up to two supported per telephone.
- 20 Button Add on Module with paper keystore, up to two supported per telephone.
- Digital Direct Station Selection (DSS) Module with 60 buttons and Paper Keystore, up to three supported per telephone.

ADM

Buttons and LEDs

The 10 button LED add on module and the 20 button keystrip add on module have programmable feature buttons that can be assigned as CO Line, Directory Number, DSS, One Touch Speed Dial or any other programmable feature.

When a Programmable Feature Button is programmed as a DSS button or a Line button, it will have an LED that provides a status of the outside line or station assigned to it. The DSS button acts like a speed dial button to a specific extension.

- A station or line shows steady red when in use by others; green when in use by your extension.
- A DSS LED will flash red while making a call and turn intermittently green once connected.
- An outside Line LED is green when the outside line is in use by your extension. It is red if it is in use by another telephone user.



Adding an ADM

For installation instructions, please refer to the Strata CIX Installation & Maintenance. Please read the caution, if you are connecting the ADM with the telephone or moving the telephone with the ADM.

CAUTION! Unplug the line cord from the DP5000-series telephone before attaching the ADM. Plugging the ADM cable in while the DP5000-series telephone is powered will damage or impair the functionality of the telephone, ADM or both.

Brightness Control

- To change the Brightness Control for a 10 button LCD add on module, refer to [“Brightness Control” on page 13](#).

Keystrip Labels

- To label the keystrip buttons on the 10 button LCD add on module, refer to [“Keystrip Labels” on page 15](#).

DSS Console

The 60 button Direction Station Selection (DSS) Console operates alongside a digital telephone to provide 60 (up to 180) additional buttons (shown right).

The 60 programmable feature buttons can be assigned as Exchange (CO) line, extension, DSS, One Touch Speed Dial or any other flexible feature.



The DDM5060 console uses dual red and green LEDs to show call and feature status.

DSS Buttons

DSS buttons can appear on both the ADM and DSS Console. Each DSS button is associated with a particular station in your telephone system. DSS buttons can transfer an outside call to the associated station or make a direct call to the associated station.

The DSS LED lights steady red when the station associated with the DSS button is ringing, busy on a call, or is idle, but all appearances of the station's extensions are busy or in-use by other stations. When the associated DSS button is in the Do Not Disturb mode, the LED blinks red at a slow rate.

DSS buttons cannot directly call station Phantom extension numbers, Distributed Hunt Group Directory Numbers, or ACD Groups. DSS buttons may be configured as One Touch Buttons that may be programmed to call these destinations.

Calling a Station

- To call a station's extension from either a DSS console or a ADM, press the DSS associated with the station.

A station call with a DSS button can be made on-hook or off-hook, and with Voice First or Tone signalling. After pressing the button, treat the call like any other station call made from a digital telephone.

Transferring to an Idle Station

You can transfer internal or outside calls to an idle station from either a DSS console or a ADM.

► To transfer a call to an idle station

1. Press the DSS button corresponding to the station to be called.

The call is placed automatically on hold. The Line or extension LED flashes green at double the on-hold rate, and the DSS LED flashes green. You hear a single ring tone. (If using the Tone signalling mode, you hear successive ring tones.)

2. Announce the call.

With Tone signalling, you would have to wait for the called station to answer before announcing the call.

3. Hang up.

The call rings the called station when you hang up. While the called station is ringing, the DSS LED is steady red, and the Line LED flashes green at the on-hold rate or if on an extension button, it goes idle.

When the called station answers the call, the DSS LED stays steady red, and the Line LED becomes steady red.

4. If the station does not answer before a period set in system programming, the call recalls your station.

Call Transfer with Camp-on

You can transfer a call to a busy station from either a DSS console or an ADM. Use the DSS to transfer the call, even though the DSS LED associated with the station you are “transferring to” is red.

► To transfer call to a busy station

1. Press DSS corresponding to the busy station to be called.

You may hear a busy tone. The original caller is placed automatically on hold. The Line or extension LED flashes green at double the on-hold rate, and the DSS LED remains steady red.

2. Hang up.

The call rings the called station once with the camp-on tone. While the called station is receiving this tone, the Line LED flashes green (on-hold rate) or if you are on a extension button, it goes idle. The [DSS] LED remains steady red.

When the called station answers the transferred call, the Line LED becomes steady red. The [DSS] LED remains steady red.

Note If the busy station is in the Do Not Disturb mode, the call will not transfer, but will recall your telephone immediately.

If the call is not answered after a specified Recall time set in system programming, camp-on is cancelled and the transferred call rings back.

Call Answering (Outside Line)

If your ADM or DSS console is equipped with a Line button, you can answer outside line calls from the ADM or DSS console as you would from a digital telephone.

- To answer an incoming outside line call to a ADM or DSS Console, press the flashing Line.

Speed Dial

Your ADM or DSS console may be equipped with SD (Speed Dial) buttons that can be programmed to dial telephone numbers or to access features. SD buttons on either the ADM or DSS console function like SD buttons on digital telephones.

Paging

You can make an announcement page to a group of telephone speakers selected in system programming with All Call Page on the DSS console. SD (if programmed) on either the DSS console or the ADM can be used for page announcements. See [“All Call Page” on page 58](#).

Call Forward Override (DSS Override)

Either the DSS buttons on your DSS console or the associated telephone can be set in system programming to ring stations that are in the Call Forward mode, instead of being forwarded. Usually the console's telephone is the unit activated to perform this function. Among other applications, this feature can be used to notify a person who forgets to deactivate the Call Forward feature after returning to the office.

► To override call forward with the console's associated telephone

1. Press  or extension button.
2. Dial the station number set for call forward.

Make the call as you would from any other station. This procedure assumes your station has a typical program setting.

► To override call forward with your DSS Console

- Press the station DSS button set for Call Forward.

Night Transfer Button

This button enables a pre-programmed station to place the system into Day, Day2 or Night Mode. See your System Administrator for information on the settings for Day, Day2 or Night Mode. These modes will transfer calls to a designated location or voice mailbox, depending on programming.

1. Press Night Transfer.
2. Press the desired Mode number:
 - Press 1 for Day Mode (LED remains off).
 - Press 2 for Day2 Mode (LED flashes red).
 - Press 3 for Night Mode (LED is solid red).

This page is intentionally left blank.

Headset and Handset Operation **5**

The DP5000-series telephone come standard with a built-in headset interface.

Recommended Headsets

For an extensive list of recommended and supported headsets please visit Toshiba's website at www.telecoms.toshiba.co.uk

Important! *If you experience any electrical interference when using a wireless headset, please follow headset manufacturer's recommendations or ensure the headset base unit is at least six inches from your telephone.*

Headset and Handset Interactions

When headset is connected and handset is off hook, you can use handset only.

When headset is connected and handset is on hook, you can use headset.



The handset and headset cannot be used simultaneously.

AUTO or CARBON Setting





There exist two types of headsets: ECM and Carbon. The default setting on the telephones is AUTO. When the headset is connected to the Headset Modular Connector of the telephone, the AUTO setting enables the headset I/F current detector to determine which headset type is connected (EMC or Carbon). If the current is marginal using a carbon headset (only) and performance is not good, change the setting to CARBON.

► To change the setting from Auto to Carbon

Telephones: All except the Single Line Telephone



1. Press 3+6+9+ (simultaneously).
2. Press .
3. Press FB3 to toggle On/Off.
FB3, LED On: CARBON
FB3, LED Off: AUTO (default)
4. Press  to set the option.
5. Go off-hook, then on-hook to exit the program mode.

Telephones: Single Line Telephone





1. Press 3+6+9+ (simultaneously).
2. Press  and press 3.
3. Press  to toggle On/Off.
Msg LED On: CARBON
Msg LED Off: AUTO (default)
4. Press  to set the option.
5. Go off-hook, then on-hook to exit the program mode.

► **To change the headset transmit level to Low or Normal**

Telephones: All except Single Line Telephone

1. Press 3+6+9+  (simultaneously).
2. Press .
3. Press FB2 to toggle On/Off.
FB2, LED On: Low
FB2, LED Off: Normal (default)
4. Press  to set the option.
5. Go off-hook, then on-hook to exit program mode.

Telephones: Single Line Telephone

1. Press 3+6+9+  (simultaneously).
2. Press  and press 2.
3. Press  to toggle On/Off.
Msg LED On: Low
Msg LED Off: Normal (default)
4. Press  to set the option.
5. Go off-hook, then on-hook to exit the program mode.

Headset Transmit Level Adjustments

- **To set the level of the Headset Transmitter for DP5000-series telephones**
 1. Press 3+6+9+  (simultaneously).
 2. Press #.
 3. Set the headset transmit level using FB1, FB2 and FB3. For Single Line Telephone (SLT), use 1,2,3 and Msg. See table below.

Headset Transmit Level					
Transmit Level		FB1	FB2	FB3	Level
	SLT	Press 1 and Msg	Press 2 and Msg	Press 3 and Msg	
Max. (louder) ↑		OFF	OFF	OFF	+12 dB
		ON	OFF	OFF	+8 dB
		OFF	ON	OFF	+4 dB
Default		ON	ON	OFF	0 dB
↓ Min. (softer)		OFF	OFF	ON	-4 dB
		ON	OFF	ON	-8 dB
		OFF	ON	ON	-12 dB
		ON	ON	ON	-16 dB



Note ON means LED ON; OFF means LED OFF

4. Press .
5. Go Off-hook, then on-hook to exit the program mode.

Handset Level Adjustments

Change the Carbon setting if a Carbon type handset or headset is connected to the handset jack. This feature is not available on the Single Line Telephone (SLT).

► **To change the Carbon Setting**



1. Press 3+6+9+  (simultaneously).
2. Press .
3. Press FB1 to toggle On/Off.

FB1, LED On: Carbon type handset

FB1, LED Off: DP5000 ECM handset (default)

4. Press  to set the option.
5. Go off-hook, then on-hook to exit the program mode.

► **To adjust the Handset Transmit Level for DP5000-series telephones**

1. Press 3+6+9+  (simultaneously).
2. Press .
3. Set the level using FB1, FB2 and FB3.
For Single Line Telephone, use 1,2,3 and Msg. See table below.



Handset Transmit Level				
Transmit Level		FB1	FB2	FB3
	SLT	Press 1 and Msg	Press 2 and Msg	Press 3 and Msg
Max. (louder) ↑		ON	ON	ON
		OFF	ON	ON
		ON	OFF	ON
Default		OFF	OFF	ON
↓ Min. (softer)		ON	ON	OFF
		OFF	ON	OFF
		ON	OFF	OFF
		OFF	OFF	OFF

4. Press Hold to set the option.
5. Go Off-hook, then on-hook to exit the program mode.

Headset and Handset Operation

Handset Level Adjustments

► To adjust the Handset or Headset Receiver Level for DP5000-series telephones



1. Press 3+6+9+ (simultaneously).
2. Press .
3. Set the level using the buttons shown in the table below.

Handset / Headset Receiver Level				
Transmit Level		FB4	FB5	FB6
	9-Line LCD	FB4	FB11	FB12
	SLT	Press 1 and Msg	Press 2 and Msg	Press 3 and Msg
Max. (louder) ↑		ON	ON	ON
		OFF	ON	ON
		ON	OFF	ON
Default		OFF	OFF	ON
↓ Min. (softer)		ON	ON	OFF
		OFF	ON	OFF
		ON	OFF	OFF
		OFF	OFF	OFF

4. Press  to set the option.
5. Go Off-hook, then on-hook to exit the program mode.

► To adjust the Handset Side Tone Level for DP5000-series telephones

Note This feature is not supported on the Single Line Telephone.

1. Press 3+6+9+ (simultaneously).
2. Press .
3. Set the level using the buttons shown in the table below.

Handset / Headset Side Tone Level			
Side Tone Level	DP5000-series	FB7	FB8
	9-Line LCD	FB13	FB14
Max. (louder) ↑		ON	ON
		OFF	ON
Default		ON	OFF
Min. (softer) ↓		OFF	OFF

4. Press  to set the option.
5. Go Off-hook, then on-hook to exit the program mode.

User programming allows you to customise your LCD telephone. You will be able to:

- Enter numbers in your personal Speed Dial list
- Program One Touch and Programmable Feature Buttons
- Register Call Forward assignments
- Assign Message Waiting Keys
- Assign the background music (BGM) source to be played over the telephone's speaker

Programming Feature Buttons

You can use the User Programming Mode (described below) for customising your DP5000-series display telephone without the aid of an Administrator or Service Technician. The User Programming mode is accessed with a Program button assigned to a Programmable Feature Button or through an access code. User Programming enables users to customise these features:

- **Programmable Feature Buttons** – The DP5000-series telephones have 10 or 20 Programmable Feature Buttons to which the user can assign any one of approximately 50 different features. Once a Programmable Feature Button is programmed, press the button anytime you need to use the feature.

Note Directory number and external line buttons cannot be added or deleted, but their ring tones can be individually changed. See [“Ring Tones” on page 15](#).

User Programming Mode

- To enter User Programming Mode, press the Program button
...or dial #9876. “USER PROG MODE” appears on your LCD. The Program LED is steady green.
- To exit User Program Mode Lift the handset off-hook / on-hook.

Programmable Feature Button Codes

Programmable Feature Buttons are the unassigned buttons on your keypad that can be used to store features. The number of available Programmable Feature Buttons depends on your telephone model and how the buttons are preassigned by the System Administrator.

The following steps enable you to program features onto Programmable Feature Buttons.

Setting/Changing a Programmable Feature Button's Function

1. Press #9876 to enter User Programming Mode.
2. Press .
3. Press the Programmable Feature Button to set or change.
4. Enter the Programmable Feature Button Code (see [Table 12](#)), plus any optional parameters.
5. Press the same Programmable Feature Button (flashing) to save the setting. "DATA PROGRAMMED" appears on your LCD.

Table 12 Programmable Feature Button Codes

Feature	Code
Account Code	660
Automatic Busy Redial - On	150
Automatic Callback	160
Background Music	530
Call Forward - Any Calls	
All Call	340
Busy	350
No Answer	360
Busy No Answer	370
Call Forward - External (Outside) Calls	
All Call	380
Busy	390
No Answer	400
Busy No Answer	420
Call Park Orbit	170
Call Pickup	
Incoming - Group Pickup	430
Incoming - Directed Extension Pickup	440
Incoming - Directed Group Pickup	450
Incoming - Directed Extension Pickup	460
On hold - Local Retrieve	490
On hold - Remote Retrieve	500
On hold - Outside Line Retrieve	480
On hold - Directed Extension Retrieve	510
On hold and Incoming	520
Incoming - Any External Call	470

Feature	Code
Caller ID	580
Cancel	290
Do Not Disturb (On/Off)	180
Door Lock Cancel	540
DSS Button	610
Flash - Short	200
Flash - Long	210
Microphone Cut-off	840
One Touch Button	570
Paging	
Page All Groups	220
Page Individual Groups	230
Emerg. Page - Individ. Group	250
Emerg. Page - All Groups	240
Answer Page - All Groups	590
Phantom Extension Message Waiting	560
Privacy	320
Privacy Release	330
Night Transfer	600
Record to VM	630
Pause/Resume recording	640
Release Button	270
Release/Answer	280
Split	860
Speed Dial	260
User Programming Mode	650

One Touch Buttons

One Touch buttons can be used for storing frequently used features or dialed numbers, such as Speed Dial numbers (use Speed Dial Codes to store additional numbers). One-touch buttons can be preassigned to your telephone – your System Administrator can help you identify them.

If you do not have a One Touch button, but you have an available Programmable Feature Button, you can convert the Programmable Feature Button to a One Touch button. Perform the procedure called “[Setting/Changing a Programmable Feature Button’s Function](#)” on [page 85](#) (in Step 4, enter the access code for One Touch button). Once you have created a One Touch button, you can change the function by using the following procedure.

Changing a One Touch Button

1. Press #9876 to enter User Programming Mode.
2. Press the One Touch button to be set.
3. Enter the digits or special buttons for the function to be dialed. You can include the following in the dial string:
 - Dial pad digits 0~9. To program special characters, see [Table 13](#).
 - A maximum of 32 characters.
 - Station and System Speed Dial index numbers can be entered. The Speed Dial index number will automatically dial out on the extension or Line programmed on the One Touch button with the associated Speed Dial index number.
 - Function buttons, except One Touch or a Program button.
 - Handset hooking (on-hook/off-hook) cannot be recorded.
4. Press the One Touch button to save the entry.

We suggest labelling the One Touch button on your button strip.

Table 13 Special Characters

Entry	Meaning
* + Hold	Indicates “stop.” The One Touch button blinks rapidly and stops the delivery of the remaining digits in the string until it is pressed again. Multiple “stops” can be programmed into one string.
* (1–9)	Pause (1–9) seconds. If you need to pause longer than nine seconds, enter additional pause escape sequences. For example, to insert a 17-second pause, enter *9*8. The display of a pause in the Speed Dial Number shows a “P” without specifying the duration. In this example, you would see “PP.”
* *	*
* #	#

Example of Special Character Usage

To create a One Touch for Park and Page under one button, program the following sequence under the One Touch button.

➤ CNF #33***HOLD FB1 #30

CNF – puts the caller on hold and gets new dial tone.

#33 – code to park call

* * – this special character outputs a single * which will select an available orbit and display the selected orbit on the phone.

*HOLD – This special character is a Stop. The dial string pauses and enables the user to view the selected orbit on the display. The dial string will restart from this point when the One Touch button is pressed again.

FB1 – gets new dial tone on the PDN

#30 – code for All Call Page which allows the user to page the location of the orbited call.

To Use a One Touch Button

➤ Press the One Touch button.

Setting/Changing a Personal Speed Dial Code

See “Storing a System/Station Speed Dial Number” on page 61.

Feature Codes

Feature Access Codes are entered as a sequence on your telephone to use a particular feature. For an example of Call Forward, see “[Call Forward Examples](#)” on page 35.1

Table 14 Feature Access Codes





Feature	Feature Access Code Sequences ¹
Account Code (while on a call)	 + #46, dial account code digits
Attendant Console	Ext. button + 0
Automatic Busy Redial - On	 + #441, hang up
Automatic Busy Redial - Off	Ext. button + #442
Automatic Callback (while on a call)	4 when you hear busy tone
Automatic Callback Cancel	Ext. button + #431
Background Music	
Telephone Speaker On	Ext. button + #490 + music source no. (1~15) + #
Telephone Speaker Off	Ext. button + #491 + 
External Speaker On	Ext. button + #492 + music source no. (1~15) + #
External Speaker Off	Ext. button + #493 + 
Call Forward - See Table 15 on page 105.	
Call Park	
Activate (while on a call)	 + #33 + Orbit Number (7000~7019) or an Ext. No.
Retrieve (while on a call)	Ext. button + #32 + Orbit Number (7000~7019) or an Ext. No.
Call Pickup	
Directed DN pickup of ringing or held calls.	Ext. button + #5#6 + Ext. No
Directed DN pickup of ringing, held or parked calls.	Ext. button + #5#29 + Ext. No. to be picked up
Incoming - Group Pickup	Ext. button + #5#34 + Group Number to be picked up
Incoming - Directed Extension Pickup	Ext. button + #5#5 + Primary Ext. No to be picked up
Incoming - Directed Group Pickup	Ext. button + #5#32 + Group Number to be picked up
Incoming - Directed Extension Pickup	Ext. button + #5#22 + Ext. Number
All Call Page, Group Page and/or External Page Pickup of page	Ext. button + #5#36 + Page Zone No. (01~08)
	#5#5 + Ext. No. of another phone being paged.



Table 14 Feature Access Codes (continued)

Feature	Feature Access Code Sequences ¹
Call Pickup for calls on Hold	
Local Pickup (call held on this phone)	Ext. button + #5#71
Remote Pickup (pickup another extension)	Ext. button + #5#72 + Primary Ext. No.
Pickup an Outside Line on Hold	Ext. button + #5#73 + Outside Line on hold (001~128)
Pickup a an on Hold	Ext. button + #5#74 + Ext. No. on hold
Conferencing - Three Way	#494
Dialing Special Characters from a Rotary Phone	
Simulate Dialling *	Dial 441
Simulate Dialling #	Dial 440
DISA Security Code - Change	Ext. button + #658 + old Security Code (1~15 digits) + # + new Security Code (1~15 digits) + #
Distinctive Ringing - See “Ring Tones” on page 15.	
Do Not Disturb	
Local - On	Ext. button + #6091
Local - Off	Ext. button + #6092
Remote - On	Ext. button + #6191 + ext. no. of the phone where DND will be set + Pass Code Number + #
Remote - Off	Ext. button + #6192 + ext. no. of the phone where DND will be set + Pass Code Number + #
Door Lock Control	Ext. button + #12 + Door Lock Number
Door Phone Calling	Ext. button + #15 + Door Phone No. (01~24, depending on system size)
Emergency Call	Ext. button + #911
Flash - Short	Ext. button + #450
Flash - Long	Ext. button + #451
LCD Language (Change)	Ext. button + #495 + Language No.
LCR (Outgoing Call)	Ext. button + 9
Message Waiting (MW)	
Manually turn off MW LED	Ext. button + #409
Retrieve a received MW	Ext. button + #408

Table 14 Feature Access Codes (continued)

Feature	Feature Access Code Sequences ¹
Activate MW at another Station without Ringing	#63 + Ext. no. (where you want to light the MW LED)
Cancel MW at another Station without Ringing	#64 + Ext. no. (where you want to turn off the MW LED)
Messaging - Advisory	
Advisory Message - Activation	Ext. or Phantom Ext. button + #411 + Message No. (see table in “Advisory Messages” on page 28). Hang up.
Advisory Message - Cancellation	Ext. or Phantom Ext. button + #412. Hang up.
Network Access Code (Private Network)	8 + Private Network No.
Night Ring Answer	Ext. button + #5#39
Off-hook Call Announce or Busy Override	Voice First: 2; Tone First: 1, 21, 12, or 5, depending on programming for your phone.
Override	
Busy, Do Not Disturb	After reaching a busy or DND station, press 2.
Executive	After reaching a busy station, press 3
Paging	
Page All Groups	Ext. button + #30
Page Individual Groups	Ext. button + #31 + Page Zone No. (01-08)
Emergency Page - Individual Group	Ext. button + #38 + Group Number
Emergency Page - All Groups	Ext. button + #37
Answer for External Group Page	Ext. button + #5#36 + Page Zone No. (01-08)
Repeat Last Number Dialed	Ext. button + *0

Table 14 Feature Access Codes (continued)

Feature	Feature Access Code Sequences ¹
Speed Dial (Storing an SD number)	
Station ²	#66 + nnn + Phone No. ³ + # nnn = 100~199 SD bin numbers
System ²	#66 + nnn + Phone No. ³ + # nnn = 200~999 SD bin numbers
Speed Dial (Dialling a stored SD number)	
Station ²	 ⁴ + nnn nnn = 100~199 Station SD bin numbers
System ²	 ⁴ + nnn nnn = 200~999 System SD bin numbers
Start Application	#18
Travelling Class Override	
Enter Code	#471, then dial number (enter LCR code if required)
Change Code	#69 + Index Number + old Code + # + new Code + #
Uniform Call Distribution	
Login from Agent Station	#6061
Logout from Agent Station	#6062
Login to Agent Station—another Station	#6161
Logout to Agent Station—another Station	#6162
User Programming Mode	#9876
Voice Mail (VM)	
Direct Transfer to Voice Mail	While on a call, press  + #407. Dial VM mailbox number (usually Ext. Number) + #.
Volume Control - Beep	With handset off-hook, press #6101. Press Vol ▲ or ▼.
Volume Control - Ringing	With handset on-hook, press #6102. Press Vol ▲ or ▼.

1. If you have “hot dialling,” you do not need to press Ext. button as part of the sequence.
2. Stations must be assigned/enabled SD capabilities in system programming by an Administrator in Program 200-30 (System SD) and Program 200-35 (Station SD).
3. Refer to [Table 10 on page 62](#) to see how to enter * and # into a speed dial number.
4. If your telephone does not have a Spdial button, press the * button, then dial the three digit Speed dial number (nnn).

This page is intentionally left blank.

This appendix contains some of the functions that can be performed using Administrator Mode.

Important!

- These functions require Strata CIX 5.1 or higher system software.
- To access the Admin mode, the telephone must be enabled for these functions in system programming using eManager. Refer to “*Strata CIX Programming Manual, Volume 1*” for eManager programming.

Functions

Use the Soft Keys on the telephone to program the following functions in Administrator mode:

- Phone Name – enter the Extension (PDN) name for any telephone in the Strata CIX
- Door Name – enter door phone name
- System SD/Name¹ – system speed dial names
- Station SD/Name¹ – station speed dial names for any telephone in the system
- Exchange (CO) Line Name – Exchange (CO) line names
- DNIS Name – DNIS names
- Phone Key Label – button names on the electronic telephone key strips
- LM Key Label – button names on the Add-on module key strip

¹ The Admin telephone mode allows speed dial names to be programmed, but the actual speed dial numbers are programmed using the speed dial programming procedures described in the User Guide.

Administrator Mode

To access Administrator Mode, your station must be enabled for administrative access.



If Mode soft key is not available when telephone is idle, the telephone set does not have Administrative access.

► To enter Administrator Mode

1. Press Mode soft key.
2. Press ADMN soft key. The “Password” prompt appears.
Enter the password (0000 – default).
3. Press .



Follow the steps below to perform the following Administrator functions in Administrator Mode.

Phone Name



1. Enter Administrator Mode
2. Press .
3. Enter the DN ID number. This is the extension number (PDN) of the telephone.
4. Enter the Phone Name that corresponds with that DN ID.
5. Press  to register the name and move on to the next Phone name entry.
6. Press RTRN softkey.
7. Repeat steps 1~4 to program additional names.

Door Name

Door Phone should be setup and programmed within the Strata CIX before a Door Name can be assigned.

1. Enter Administrator Mode.
2. Press Next, display shows Door Name
3. Press , display shows Door Phone Number.
4. Enter the Door Phone number (01~24).
5. Enter the Door Phone name
6. Press  to save the name.
7. Repeat steps 4~6 to enter another Door Phone name.



System SD/Name

1. Enter Administrator Mode.
2. Press Next twice until display show System SD/Name.
3. Press , display shows IDX
4. Enter three digit Speed Dial Index (000~799).
5. Enter the Speed Dial name/label.
6. Press  to save your changes
7. Repeat steps 4~6 to label additional Speed Dials.



Phone Key Label and LM Key Label

See [Chapter 4 – ADM/DSS Console](#).



Station SD/ Name

1. Enter Administrator Mode.
2. Press Next three times, display will show Station SD/Name
3. Press , display shows DN ID
4. Enter the DN number of the station whose speed dial you wish to label, display will show DN XXXX IDX
5. Enter the two digit Speed Dial number you wish to program, display shows DN XXXX IDX 01
6. Enter the name/label of this Station Speed Dial.
7. Press , to save your changes.
8. To label additional Speed Dials for this extension, repeat steps 5~7.
9. To label Speed Dials for another extension, press Rtrn, display will show DN ID and repeat steps 4~7.

Exchange (CO) Line Name

1. Enter Administrator Mode
2. Press Next four times, display will show Exchange (CO) Line Name.
3. Press , display will show Exchange (CO) Line.
4. Enter the Exchange (CO) line number whose name you wish to change (001~264), if you enter 001 display will show Exchange (CO) Line 001
5. Enter the name/label for the Exchange (CO) Line
6. Press , to save your changes.
7. Repeat steps 4~6 to change addition Exchange (CO) Line names.

DNIS Name

1. Enter Administrator Mode.
2. Press Next five times, display will show DNIS Name.
3. Press , display will show ILG (Incoming Line Group)
4. Enter the ILG number whose name you wish to change (001~128), if you enter 001 display will show ILG 001
5. Enter the name/label for the ILG.
6. Press , to save your changes.
7. Repeat steps 4~6 to change addition ILG names.

System Features

The following are system features that require Administrator setup using the DP5000-series telephone. For eManager programming refer to the *Strata CIX Programming Manual, Volume 1*.

Direct Inward System Access (DISA) Security Code

The Direct Inward System Access feature is used when calling into your system from the outside. This feature is available on certain Exchange (CO) lines and from the built-in Auto Attendant. Assignments are made by the system programmer. Exchange (CO) lines can be DISA lines in the Day, Day 2, or Night mode, or any combination of these modes.

If a caller enters the system via a DISA line or built-in Auto Attendant, the caller can then access another line to place an outgoing call through the system, in which case the outgoing line call is charged as a call made from the CIX system. To prevent unauthorised outgoing calls through the system using the DISA feature, enter a DISA security code as shown in the following steps.

CAUTION! Whenever the built-in Auto Attendant is installed, the DISA security code should be used (and changed periodically) to prevent unauthorized access of outgoing Exchange (CO) lines via the Auto Attendant DISA access feature.

► To change the DISA security code

1. Press DN + DISA Security Access Code (see note). A confirmation tone is heard.
2. Dial the existing DISA security code (1-15 digits).
3. Press #, confirmation tone is heard.
4. Enter the new DISA security code + #, confirmation tone is heard and display shows Data Programmed.
5. Lift handset off-hook and on-hook to end session.

► To cancel the DISA security code

CAUTION! Canceling the DISA security is very dangerous and allows your telephone system to be open to hackers and could result in unauthorised long distance telephone calls. Perform the following steps with caution.



1. Press DN + DISA Security Access Code (see note). A confirmation tone is heard
2. Dial the existing DISA security code (1-15 digits)
3. Press #, confirmation tone is heard.
4. Press # again, this will allow the DISA feature to be used without a security code.
5. A confirmation tone is heard and display shows Data Programmed.
6. Lift handset off-hook and on-hook to end session.

Note The DISA Security Access Code needs to be defined in the Strata CIX by the System Administrator through eManager as it is not set in the default database.

Date and Time Setting

This operation is possible from the Administrator station or attendant consoles and enables you to set the date, time, and day.



► To set the date

1. With the handset on-hook, press a DN + the access code assigned in eManager.
A confirmation tone is heard.
2. Enter the date (YYMMDD).
3. Press .
- A confirmation tone is heard.
4. Press .
- The telephone returns to the idle mode.

► To set the time

1. Press DN + the access code assigned in eManager, with the handset on-hook.
A confirmation tone is heard.
2. Enter the time (HHMMSS) in the 24-hour clock format.

Note H=hour, M=minute and S=seconds. Use leading zeros: 060530 = 6:05AM and 30 seconds; 143045 = 2:30PM and 45 seconds.





3. Press .
- You hear a confirmation tone.
4. Press .
- The telephone returns to the idle mode.

Telephone Programming Mode

- ▶ **To place your telephone in Programming Mode A**
 - ▶ Press 3+6+9+ simultaneously. The LCD displays “DP PROGRAM MODE” and “SELECT=”. Your phone will not ring if it receives a call while in Programming Mode.
- ▶ **To exit from Programming Mode A**
 - ▶ Go Off-hook and On-hook or wait for 30 seconds for Programming Mode to automatically time out.



Initialise Telephone Settings

This function resets all Programming Mode option settings to their default setting.

1. Press 3+6+9+ (simultaneously).
2. Press Mode soft key.
3. Press  button.
4. Press .
5. Press VOL ▲ button.
6. Press .
7. Press .
8. Go off-hook, then on-hook to exit the program mode.





Call Waiting and Camp-on Ring Tone Over Handset/Headset Option

Call Waiting and Camp-on tones are sent to a busy telephone's speaker to indicate that a call is waiting. Call Waiting and Camp-on Tones can be sent, as an option, to the telephone handset or headset, in addition to the speaker. Follow these steps to turn handset/headset Call Waiting and Camp-on tone On/Off for a DP5000-series telephone. The default is Off.

1. Press 3+6+9+  (simultaneously).
2. Press 0.
3. Press Feature Button 4 (FB4) to toggle On/Off.
FB4, LED On: Call Waiting tone
FB4, LED Off: No Call Waiting tone
4. Press  to set the option.
5. Go off-hook, then on-hook to exit the program mode.

Initialise or Adjust LCD Contrast

► To initialise LCD Contrast for the LCD Telephones

1. Press 3+6+9+  (simultaneously).
2. Press Mode soft key.
3. Press  button so that the  LED is On.
4. Press . This sets the LCD lightness/darkness contrast to the default setting.
5. Go off-hook, then on-hook to exit the program mode.

► To adjust LCD Contrast for the LCD Telephones

- Press and hold down the  button while you press and release Vol ▲ or Vol ▼ repeatedly.

Each time you press Vol ▲ or Vol ▼, the contrast increases or decreases. There are a total of 13 different contrast levels available.

DKT2000 Mode On/Off

Important! *This feature is not available in the U.K.*



Before a cordless telephone (DKT2204-CT or DKT2304-CT) can share a digital station port with a DP5000-series telephone set, the port must be programmed into 2000 mode. If the mode is not changed to 2000-mode, the DP5000 phone will not work and the display will be blank. Also see *CIX Installation and Maintenance Manual* for additional information.

In 2000-mode:

- Only 16 characters by two lines display on the LCD.
- LCD Programmable Feature Button does not work
- Spdial button does not work

Step 1: Turn DKT2000 Mode On/Off

Important! Change the mode on DP5000-series telephone before connecting a DKT2204-CT or DKT2304-CT.

1. On the DKT3x00 telephone, press 3+6+9+  (simultaneously).
2. Press #.
3. Press FB7. LED On = 2000 telephone. LED Off = 5000-series telephone.
4. Press .
5. Lift the handset to exit programming mode. Wait a few seconds for the telephone to reset itself.

Step 2: Connect Cordless Telephone to DP5000-series Telephone

The cordless telephone (base station) will connect to the digital station port and then in turn the DP5000 phone will connect to the cordless base station.

Single Line Telephone

The Single Line Telephone is the smallest telephone set in the DP5000-series family. This telephone has some variations on button functionality compared to the other DP5000-series telephones. These differences are detailed here.

Buttons

Some of the fixed buttons are a little different from the other DP5000-series telephones.



Message (Msg) – This button is used to call back the station or voice mail device that activated the LED.

Redial – Redial button by default. This button can also be programmed as a Programmable Feature Button.

Off-hook – This button works as a PDN that can be used to answer and make calls.



Redial Button Activation / Deactivation

The  button has been set to act as a Redial button by default. However, you can reprogram the  button to work as Programmable Feature Button, as it set in system programming. These steps enable you to change how the button functions.

1. Press 3+6+9+  (simultaneously).

2. Press 0 7.

3. Press  to toggle On/Off

Msg LED On: Redial button works as Programmable Feature Button (FB3)



Msg LED Off: Redial button works as a Redial button.

4. Press  to set the option.

5. Go off-hook, then on-hook to exit the program mode.

Note If you program the Redial button to work as Programmable Feature Button 3, you can press *0 to redial.

Msg / Feature Button Activation / Deactivation

Your  button has been set by default to work as a  button; however, you can reprogram it to work as Programmable Feature Button.

1. Press 3+6+9+  (simultaneously).

2. Press 0 8.

3. Press  to toggle On/Off.

Msg LED On:  operates as Programmable Feature Button (FB2)

Msg LED Off: Works as a Msg button.

4. Press  to set the option.

5. Go off-hook, then on-hook to exit the program mode.

Note Please see your System Administrator to have Features assigned to the Redial or Msg buttons, this will be done through eManager.

This Appendix contains table that support some of the feature operations.

Call Forward

Table 15 Call Forward Procedure

Feature	Button Sequence
Call Forward Any Call - Internal and Incoming Line Calls: Forwards any call, whether an internal call or incoming line call.	
All Calls to an ext.	Press ext. button + #6011 (tone) + dial the dest. ext. no. (tone)
All Calls to outside telephone no.	Press ext. button + #6011 (tone) + outside line access code + dest. telephone no. + # (tone)
Busy to an ext.	Press ext. button + #6021 (tone) + dial the dest. ext. no. (tone)
Busy to outside telephone no.	Press ext. button + #6021 (tone) + outside line access code + dest. telephone no. + # (tone)
No Answer to an ext.	Press ext. button + #6031 (tone) + dial the dest. ext. no. + timer (08~60) (tone)
No Answer to outside telephone no.	Press ext. button + #6031 (tone) + outside line access code + dest. telephone no. + # (tone) + timer (08~60) (tone)
Busy No Answer to an ext.	Press ext. button + #6041 + dial the dest. ext. no. # (tone) + timer (08~60) (tone)
Busy No Answer to outside telephone no.	Press ext. button + #6041 + outside line access code + dest. telephone no. + # + timer (08~60) (tone)
Cancel	Press ext. button + #6051 (tone)

References

Call Forward

Table 15 Call Forward Procedure (continued)

Feature	Button Sequence
Call Forward - Incoming Line Calls: Forward incoming line calls only.	
All Calls to an ext.	Press ext. button + #6013 (tone) + dial the dest. ext. no. (tone)
All Calls to outside telephone no.	Press ext. button + #6013 (tone) + outside line access code + dest. telephone no. + # (tone)
Busy to an ext.	Press ext. button + #6023 (tone) + dial the dest. ext. no. (tone)
Busy to outside telephone no.	Press ext. button + #6023 (tone) + outside line access code + dest. telephone no. + # (tone)
No Answer to an ext.	Press ext. button + #6033 + dial the dest. ext. no. (tone) + timer (08~60)
No Answer to outside telephone no.	Press ext. button + #6033 + outside line access code + dest. telephone no. + # (tone) + timer (08~60)
Busy No Answer to an ext.	Press ext. button + #6043 + dial the dest. ext. no. (tone) + timer (08~60) (tone)
Busy No Answer to outside telephone no.	Press ext. button + #6043 + outside line access code + dest. telephone no. + # (tone) + timer (08~60) (tone)
Cancel	Press ext. button + #6053 (tone)
Call Forward Any Call - Set for Another Station: Enables you to set call forwarding for another telephone within your telephone system. You will need the other telephone's Call Forward pass code in order to do this. Call Forward Pass Codes are created in system programming.	
All Calls to an ext.	Press ext. button + #6012 (tone) + dial the other telephone's ext. no. + enter other telephone's Call Forward pass code + # + dest. telephone no. (tone)
All Calls to outside telephone no.	Press ext. button + #6012 (tone) + dial the other telephone's ext. no. + enter other telephone's Call Forward pass code + # + outside line access code + dest. telephone no. + # (tone)
Busy to an ext.	Press ext. button + #6022 (tone) + dial the other telephone's ext. no. + enter other telephone's Call Forward pass code + # + dest. telephone no. (tone)
Busy to outside telephone no.	Press ext. button + #6022 (tone) + dial the other telephone's ext. no. + enter other telephone's Call Forward pass code + # + outside line access code + dest. telephone no. + # (tone)

Table 15 Call Forward Procedure (continued)

Feature	Button Sequence
No Answer to an ext.	Press ext. button + #6032 (tone) + dial the other telephone's ext. no. + enter other telephone's Call Forward pass code (tone) + # + dest. telephone no. (tone) + timer (08~60) (tone)
No Answer to outside telephone no.	Press ext. button + #6032 (tone) + dial the other telephone's ext. no. + enter other telephone's Call Forward pass code (tone) + # + outside line access code + dest. telephone no. + # (tone) + timer (08~60) (tone)
Busy No Answer to an ext.	Press ext. button + #6042 + dial the other telephone's ext. no. + enter other telephone's Call Forward pass code + # (tone) + dest. telephone no. (tone) + timer (08~60) (tone)
Busy No Answer to outside telephone no.	Press ext. button + #6042 + dial the other telephone's ext. no. + enter other telephone's Call Forward pass code + # (tone) + outside line access code + dest. telephone no. + # (tone) + timer (08~60) (tone)
Cancel	Press ext. button + #6052 (tone) + dial the other telephone's ext. no. + enter other telephone's Call Forward pass code + # (tone)
Call Forward - Incoming Line Call - Set for Another Station:	
Enables you to set forwarding of incoming line calls for another telephone within your telephone system	
All Calls to an ext.	Press ext. button + #6014 (tone) + dial the other telephone's ext. no. + enter other telephone's Call Forward pass code + # (tone) + dest. telephone no. (tone)
All Calls to outside telephone no.	Press ext. button + #6014 (tone) + dial the other telephone's ext. no. + enter other telephone's Call Forward pass code + # (tone) + outside line access code + dest. telephone no. + # (tone)
Busy to an ext.	Press ext. button + #6024 (tone) + dial the other telephone's ext. no. + enter other telephone's Call Forward pass code + # (tone) + dest. telephone no. (tone)
Busy to outside telephone no.	Press ext. button + #6024 (tone) + dial the other telephone's ext. no. + enter other telephone's Call Forward pass code + # (tone) + outside line access code + dest. telephone no. + # (tone)
No Answer to an ext.	Press ext. button + #6034 (tone) + dial the other telephone's ext. no. + enter other telephone's Call Forward pass code + # (tone) + dest. telephone no. (tone) + timer (08~60)
No Answer to outside telephone no.	Press ext. button + #6034 (tone) + dial the other telephone's ext. no. + enter other telephone's Call Forward pass code + # (tone) + outside line access code + dest. telephone no. + # (tone) + timer (08~60) (tone)

References

Call Forward

Table 15 Call Forward Procedure (continued)

Feature	Button Sequence
Busy No Answer to an ext.	Press ext. button + #6044 (tone) + dial the other telephone's ext. no. + enter other telephone's Call Forward pass code + # (tone) + dest. telephone no. (tone) + timer (08~60) (tone)
Busy No Answer to outside telephone no.	Press ext. button + #6044 (tone) + dial the other telephone's ext. no. + enter other telephone's Call Forward pass code + # (tone) + outside line access code + dest. telephone no. + # (tone) + timer (08~60) (tone)
Cancel	Press ext. button + #6054 (tone) + dial the other telephone's ext. no. + enter other telephone's Call Forward pass code + # (tone)
Change Call Forward Pass Code: Your telephone must be enabled in programming to have the ability to change pass codes.	
Change Pass Code	Press ext. button + #670 (tone) + dial the dest. ext. no. (tone) + old pass code + # (tone) + new pass code (tone) + #

Soft Keys

The table below is a list of soft key labels that appear on the LCD telephones. Press the soft key button associated with the label to activate the feature (SK1, SK2, SK3 and SK4).

Table 16 Soft Key Prompts

Soft Key	Definition
ABR	Activates Automatic Busy Redial after dialling a busy outside telephone number.
ACB	Activates Automatic Callback after reaching a busy station, Exchange (CO) line, or Exchange (CO) Line group.
BUSY	(Busy Override) Sends a call-waiting tone to a busy station.
CONF	Initiates or completes a conference.
EXEC	(Executive Override) Breaks into the conversation of a busy called station.
EXIT	Exits you from a conference; remaining parties are connected.
JOIN	Joins all parties to a conference while on a conference call.
LINE	Adds an Exchange (CO) line to an existing call while in the Conference mode. The LCD prompts you to access an Exchange (CO) line after you press this key.
MESG	Sets a message waiting indication at a busy or unanswered station.
OVRD	Overrides options, busy mode, or overrides Do Not Disturb mode.
PGE	Enables you to enter a Page Group number (01~16) and send a page to the phones in that page group.
RING	Makes a called station ring when making a voice announce call to the station.
RLS	Disconnects a call and returns telephone to the idle state.
RTRN	Terminates a feature operation and returns to a previously displayed state.
SPLT	Enables you to break off from a conference call with another conference call member for a private conversation (split). You can use the Join key to reconnect both of you back into the conference. You must be a conference master to use this. See instructions for Conference Split/Join/Drop for further instruction.
STA.	Adds a station to an existing call while in the Conference mode. The LCD prompts you to dial a station number after you press this key.
TALK	Makes a voice announcement to a called station that is ringing.
TRNS	Initiates or completes a Transfer while on an outside call.

Button Labels

The button labels in [Table 17](#) are for the Programmable Buttons on the telephone. Programmable buttons are the unmarked buttons on the telephone keypad.

Table 17 Programmable Feature Button Definitions

Button	Definitions
Account Code	Account Code – Press to enter a Voluntary Account Code anytime during an Exchange (CO) Line (outside) line call without interrupting the conversation.
All Call Page	All Call Voice Page – Press to page all of the telephones in the All Call Page group.
Auto Busy Redial	Automatic Busy Redial – Press to set up Automatic Busy Redial after receiving a busy tone on a dialled outside line call (not available when calling on Tie or Direct Dialling Inward (DDI) outside lines).
Auto Callback	Automatic Callback – Press to recall a busy station or station in the Do Not Disturb (Do Not Disturb) mode as soon as that station becomes idle or deactivates Do Not Disturb. Also used for outside line queuing when all lines are busy.
Call Frwd All Calls	Call Forward-All Calls – Press to forward all calls to another station or voice mail device.
Call Frwd Busy	Call Forward-Busy – Press to forward calls immediately to another station or voice mail device when your station is busy or in the Do Not Disturb mode.
Call Frwd Busy NAns	Call Forward-Busy/No Answer – Press to forward calls immediately to another station or voice mail device when your station is busy or in Do Not Disturb mode. Also forwards calls when your station is not answered after 8–60 seconds (set at your station).
Call Frwd No Answer	Call Forward-No Answer – Press to forward calls to another station or voice mail device when your station is not answered after 8–60 seconds (set at your station).
Call Frwd External	Call Forward-External – Press to forward Private or DDI line calls to an external or internal telephone number.
Caller ID	Caller ID – Press to view the Call History list (may include name/number, date, status).
Directed Pickup	Call Pickup – Press to initiate a ringing Directed Call Pickup of outside line, extension, and page calls.
Do Not Disturb	Do Not Disturb – Press to lock your station in or out of the Do not Disturb mode.

Table 17 Programmable Feature Button Definitions *(continued)*

Button	Definitions
DSS	Direct Station Selection(s) – Press to ring a preselected station. The LED associated with each DSS button provides the status (idle/busy) of the station assigned to the button.
Flash	Flash – Press to perform the following functions: Disconnect and recall dial tone on a outside line; access Centrex or PBX features; enter a pause or flash signal when programming speed dial numbers.
Group Pickup	Group Pickup – Press to pick up a call that is ringing a station that belongs to a Pickup Group that your station is a member of.
Line	Line – Press to answer or access an outside line.
Microphn Cut-off	Microphone Cutoff – Press to turn the microphone off/on while idle, providing privacy when you receive handsfree internal calls. Also functional when your station receives calls – The Mic button controls the microphone when you originate calls.
Msg Wait	Additional Messages Waiting
Night Transfer	Press to control the system's outside line ringing pattern for after-hours incoming calls.
Park in Orbit	Park – Press to park internal or outside calls in an orbit. Call retrieval can be made locally from the same parking telephone or remotely from a different telephone.
Pooled Line Grp	Pooled Line – Press to access an available outside line from a group of lines appearing under one button.
Privacy on Line	Privacy – Press to block Privacy Override on common outside line buttons. This button does not block Busy Override or Executive Override.
Privacy Release	Privacy Release – Press to release privacy on common outside line buttons, enabling other station users to enter your conversations on those buttons. Privacy release does not apply to common extension buttons which are always private.
Program	Program – Press to enter User Programming mode, which enables you to re-define Programmable Feature Buttons to perform other functions, including programming One Touch, Call Forward assignments, assign Message Waiting Buttons and assign BGM sources played over the telephone speaker.
PS/RES	Pause/Resume – Press to pause or resume recording a conversation to a voice mailbox or when playing back the recording.
Record	Record to Voice Mail – Press to record current conversation to voice mailbox.

References

Button Labels

Table 17 Programmable Feature Button Definitions *(continued)*

Button	Definitions
Release and Ans	Release and Answer – Press to disconnect or complete the transfer the current outside or extension call and automatically answer the new incoming outside or extension call.
Release Call	Release – Press to disconnect or complete the transfer of the current outside or extension call and to place your station in the idle condition.
SD or Customized Button	Speed Dial – Press to Speed Dial a telephone number or feature access codes. SD buttons can be used as either System Speed Dial numbers or Station Speed Dial numbers.
Spd Dial Lng Pause	Pause (Long) – Press to insert a 10-second pause when programming Speed Dial numbers.
Spd Dial Pause	Pause – Press to set either a one-half or two-second pause when programming Speed Dial numbers. (The pause time is set in system programming).
Start	Start – Press to make an outgoing call using an ISDN trunk.
Sub	Sub address – Press to enter a sub address on an ISDN trunk outgoing call.
Tel Set Music	Background Music – Press to turn Background Music on or off over your station speaker.
Tone Dial Select	Tone – Press to change the outgoing dialling of the outside line in use from dial pulse to tone signalling.
Unlock Door	Door Unlock – Press to unlock a door lock mechanism.

Table 18 Programmable Feature Button Labels

Code	Feature Name	1	2	3	4	5	6	7	8	9	10	11	12	LCD Default Label	User Can Rename
000	Unused Key														
100	Prime DN Key	E	x	t	.		x	x	x	x	x			Ext. XXXXX (CLID)	Yes
110	Secondary/ Phantom DN Key	E	x	t	.		x	x	x	x	x			Ext. XXXXX (Caller ID)	Yes

Table 18 Programmable Feature Button Labels (continued)

Code	Feature Name	1	2	3	4	5	6	7	8	9	10	11	12	LCD Default Label	User Can Rename
120	CO	L	i	n	e		x	x	x					Line XXX(Caller ID)	Yes
130	CO Line Group	L	i	n	e		G	r	p		x	x	x	Line Grp XXX(Caller ID)	Yes
140	Pooled Line Key	P	L		L	n		G	r	p	x	x	x	PL Ln GrpXXX(C aller ID)	Yes!
540	Door Unlock	D	o	o	r		L	o	c	k	x	x	x	Door Lock XXX	Yes
560	PhDN Message Waiting	M	W		f	o	r		x	x	x	x	x	MW for XXXXX	Yes
570	One Touch	O	n	e		T	o	u	c	h				One Touch	Yes
610	DSS Key	D	S	x	x	x	x	x	x	x				DSXXXXX XX	Yes
900	Application Start-Application #00-#89	A	P	P		K	e	y	9	0	0	X	X	APP Key 900XX	Yes
900	Application Start - Application #90	A	C	D		L	o	g		l	n			ACD LogIn	Yes
900	Application Start - Application #91	U	n	A	V	a	i	l	a	b	l	e		Unavailabl e	Yes
900	Application Start - Application #92	A	C	D		W	o	r	k	U	n	i	t	WorkUnit	Yes

References

Button Labels

Table 18 Programmable Feature Button Labels *(continued)*

Code	Feature Name	1	2	3	4	5	6	7	8	9	10	11	12	LCD Default Label	User Can Rename
900	Application Start - Application #93	A	C	D		H	e	l	p					ACD Help	Yes
900	Application Start - Application #94	A	C	D		P	i	c	k	U	p			ACD PickUp	Yes
900	Application Start - Application #95	E	n	d		W	r	a	p	U	p			End WrapUp	Yes
900	Application Start - Application #96	A	C	D		W	r	a	p	U	p			ACD Join	Yes
900	Application Start - Application #97	A	C	D		M	o	n	i	t	o	r		ACD Monitor	Yes
900	Application Start - Application #98	A	C	D		S	h	i	f	t				ACD Shift	Yes
900	Application Start - Application #99	A	C	D		S	t	a	t	u	s			ACD Status	Yes

DP5000-Series Telephone Tilt Angles

The DP5000-series telephones, except the Single Line Telephone have three tilt positions built into the base. There is also a tilt stand extension that adds an additional 20 degrees of tilt. When the telephone is sitting on a desk or table there are a total of six different angles of tilt available. When wall mounted there are two angles available. The Single Line Telephone base is fixed at 15 degrees. See figures on the next page.

Table 19 DP5000-Series Tilt Angles

Model	Tilt Without Stand	Tilt with Stand
All DP5000-series, except the Single Line Telephone	15°, 27.5°, 40°	35°, 47.5°, 60°
All Add-on and DSS modules		
Single Line Telephone	15 Degrees (fixed)	

Hardware Connections

DP5000-Series Telephone Tilt Angles

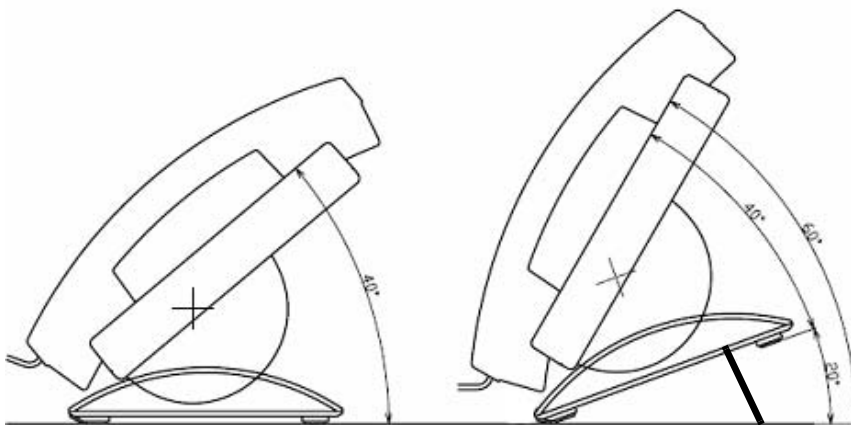

DP5000-Series Desk-top Tilt Angle With Tilt-Stand Extension

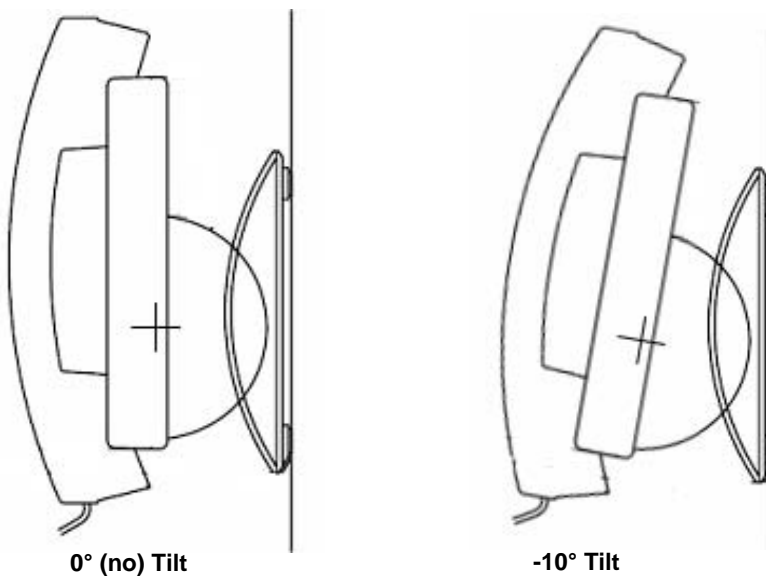

DP5000-Series Wall Mount Angles

Wiring

The connectors on the DP5000-series telephones are identified with icons. The connector icons and their meaning are shown below.

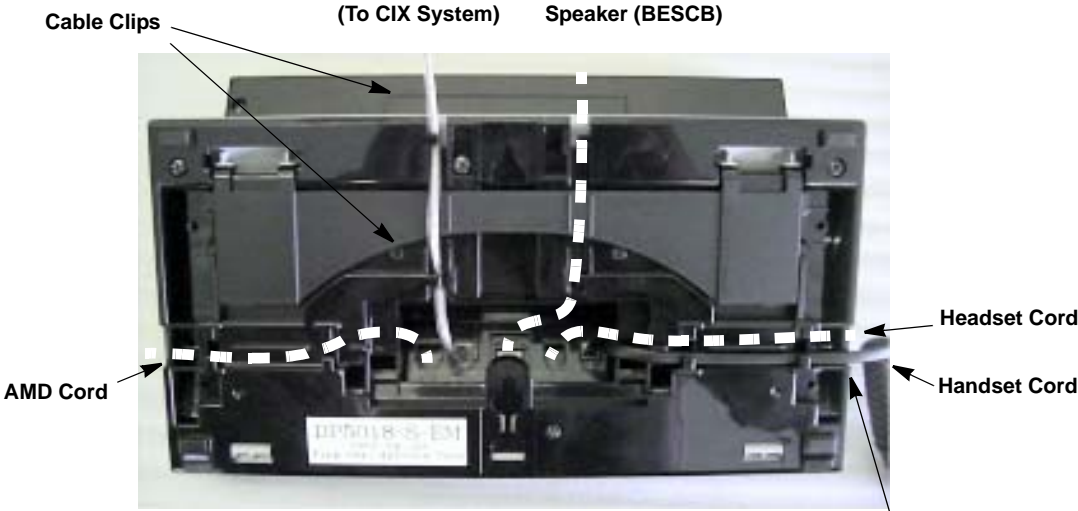
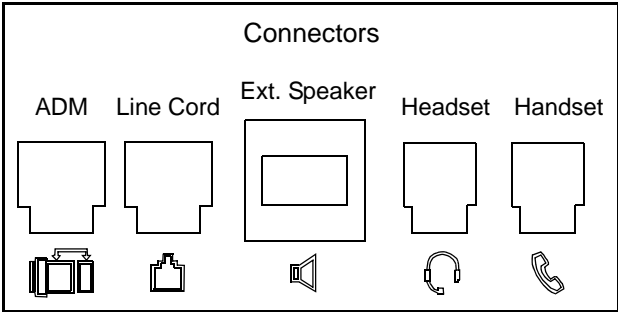

The DP5000-series telephones include the special long-tail handset cords required to fit the new tilt bases.

DP5000-series Telephone Wiring

Hardware Connections

Wiring



When the tilt stand extension is used, simply remove the line cord from under the rear cable clip. This will allow the tilt stand extension to deploy without strain on the line cord.

Important! *The Centrex Application feature applies to US models only.*

Your system may be equipped with the Centrex Application, which enhances its feature capability when installed behind a Centrex or PBX system. Your telephone may have access to one or more of the enhanced Centrex features listed below:

Flexible Directory Numbering

A station's extension can be three or four digits. It is, therefore, possible to match a station's extension and Centrex line extension number. Dial the entire station number when indicated.

Note Some access code numbers may have been changed to avoid system numbering plan conflicts.

Centrex Feature Buttons

You can access some Centrex features by pressing a pre-programmed Feature Button on your telephone, instead of dialling a Centrex access code. The Centrex access code, including the necessary flash and/or pause sequence, is activated when the button is pressed. See your Centrex or PBX operations manual for specific details.

Ringling Repeat

The distinctive ring patterns available in your Centrex system are automatically repeated with your digital telephone, enabling you to answer appropriately for either outside, inside or callback calls.

Delayed Ringling

Outside line or Centrex line(s) can be programmed for a 12-second and/or 24-second ring delay at stations to permit alternate answering conditions. Answer the line when your telephone is ringling.

Index

A

- about this book
 - conventions, [viii](#)
 - how to use this guide, [viii](#)
 - organisation, [vii](#)
 - related documents, [x](#)
- access codes, [61](#), [85](#), [88](#)
- account codes, [26](#), [85](#), [88](#)
 - calls, [25](#)
 - forced, [25](#)
 - verified/non-verified, [25](#)
- administrator
 - functions, [93](#)
- advisory messaging, [90](#)
- all call page, [58](#)
- alphanumeric entry, [63](#)
- answer a call, [21](#)
- answering calls, [19](#)
- attendant console, [88](#)
- automatic
 - busy redial, [85](#), [88](#)
 - callback, [30](#)
 - callback cancel, [85](#), [88](#)
 - hold, [23](#)
 - line selection, [18](#)
- automatic hold, [23](#)

B

- background music (BGM), [31](#), [85](#), [88](#)
- busy override, [55](#)
- button
 - feature, [104](#)
 - labels, [110](#)
 - off-hook, [103](#)
 - programming, [85](#)
 - redial, [103](#)
- buttons
 - DSS on ADMs and DSS consoles, [72](#)
 - fixed, [6](#)
 - Hold, [8](#)
 - one touch, [86](#)

C

- caller ID, [41](#)
- call forward
 - access codes, [85](#)
 - any call, [33](#)
 - override, [75](#)
 - station, [32](#)
 - system, [32](#)
- call hold, [22](#)
- calling, [19](#)
- call park, [88](#)
 - orbits, [36](#)
- call pickup, [37](#), [85](#), [88](#)

- held calls, 89
- call waiting, 40, 56, 101
- Camp-on ring tone, 101
- centrex
 - application, 119
 - feature buttons, 119
- class of service
 - override, 56
- conference
 - calls, 41, 89
 - hold, 23
 - split/join/drop, 43
 - voice mail, 42

D

- date and time setting, 99
- day/day 2/night modes, 97
- deactivation, 104
- delayed ringing, 120
- dial directory, 20
- dial pad, 63
- direct inward system access (see DISA)
- directories, 63
- direct station selection
 - buttons, 45
- DISA, 97
 - security code, 89, 97
- distinctive ringing, 15
- DKT2000 mode on/off, 102
- DNIS name, 96
- do not disturb, 46, 89
 - override, 55
- door lock, 47
 - control, 89
- door name, 95
- door phone, 48
 - calling, 89
- drop, 43

- DSS, 45
 - buttons on ADMs and DSS consoles, 72
 - call answering, 74
 - call forward override, 75
 - calling, 72
 - console, 72
 - night transfer, 75
 - paging, 75
 - speed dial, 74
 - transferring, 73

E

- emergency
 - call, 89
 - page, 58
- emergency call, 49
- emergency ringdown, 50
- exchange (CO) line
 - call transfer, 39
- exchange (CO) line name, 96
- exchange (CO) line queuing, 45
- exclusive hold, 22
- executive override, 56

F

- feature access codes, 88
- flash, 85, 89
- flexible buttons
 - codes, 85
- flexible directory numbering, 119
- forced account codes (verified/non-verified), 25

G

- group pickup, 37

H

- handset calling, 19
- handsfree answerback, 21
- Hold, 8
- hold, 22
 - line hold, 36, 39
- hot dialling, 18, 19

I

- indicators
 - LED, 24
- ISDN
 - buttons, 66, 112

J

- join, 43

L

- language changes, 89
- language code, 50
- LCD contrast, 101
- LCR
 - dialing out, 89
- LED indicators, 24
- line
 - automatic selection, 18
 - ringing preference, 18
- line button, 39

M

- making a call, 19
- message waiting, 51, 89
- message waiting light
 - on another telephone, 52
 - on phantom ext/MW, 52
- messaging
 - advisory, 90

- Mic button, 7, 22, 54
- microphone, 7, 19, 22, 53, 54
- microphone cut-off, 53, 54, 85, 111
- mute, 7, 22

N

- names
 - storing speed dial, 63
- names (entering), 63
- network access, 90
- night ring answer, 90
- night transfer button, 75

O

- off-hook, 103
- off-hook call announce (OCA), 54, 90
- one touch button, 86, 87
- override
 - access codes, 90
 - busy, 55
 - call forward (DSS), 75
 - class of service, 56
 - do not disturb, 55
 - executive, 56
 - privacy, 57
 - travelling class, 91
- override calls, 55

P

- paging, 37, 75
 - access codes, 85, 90
- park, 88
 - park in orbit, 36
- park in orbit, 36
- pickup, 37
- pick up group calls, 37
- privacy, 59

- override, 57
- private network access, 90
- programming
 - buttons, 85
- programming mode, 100

R

- redial button, 103
- redial, 104
- repeat last number dialed, 90
- ringing
 - distinctive settings, 15
 - line preference, 18
- ringing line preference, 21
- ringing repeat, 120

S

- signalling
 - tone, 18
 - voice first, 18
- soft keys, 28
- speakerphone, 22
- special characters for speed dialling, 62
- speed dial, 60, 86
 - access codes, 61, 85, 91
 - names, 63
 - personal, 87
 - station, 96
 - system, 95
- speed dial (DADM or DSS), 74
- Spkr button, 19
 - answering, 21
- split, 43
- start application, 91
- station
 - speed dial/name, 96
- storing speed dial names, 63
- system

- features, 97
- speed dial/name, 95

T

- telephone
 - buttons, 103
 - single line telephone, 103
- telephone settings, 100
- Tilt Angles, 115
- tone/pulse dialling, 66
- tone signalling, 18
- travelling class override, 91
- two (tandem) exchange (CO) line connection, 43

U

- uniform call distribution (UCD), 67
- user programming, 83, 85, 91

V

- voice first signalling, 18
- voice mail
 - access codes, 91
 - conference, 42
- volume control, 24, 91
- voluntary account codes (verified/non-verified), 27